

# **TROOP PROGRAM FEATURES**

## **VOLUME I**



# TROOP PROGRAM FEATURES

## VOLUME I

Aquatics .....	15
Athletics .....	25
Backpacking .....	35
Boating/Canoeing .....	45
Business .....	55
Camping.....	65
Citizenship .....	75
Communications.....	85
Cooking.....	95
Cultural Awareness .....	105
Emergency Preparedness .....	113
Engineering .....	123

Volumes II and III cover the following program features.

### **VOLUME II**

Environment  
First Aid  
Fishing  
Forestry  
Health Care  
High Adventure  
Hiking  
Hobbies  
Leadership  
Mechanics  
Nature  
Orienteering

### **VOLUME III**

Physical Fitness  
Pioneering  
Public Service  
Safety  
Science  
Shooting  
Special Cooking  
Sports  
Tracking  
Wilderness Survival  
Wildlife Management  
Winter Camping



# TROOP PROGRAM FEATURES

## YEARLY PROGRAM PLANNING

A successful troop meeting begins with advance planning. In recent research, the Boy Scouts of America determined that inadequately planned and executed troop meetings were the number one cause of boys leaving Scouting.

Troop meetings should focus on a monthly program feature, be fast-moving, and start and end on time. The program feature should be interwoven with the program at all experience levels: the new-Scout patrol, experienced patrols, and the Venture patrol.

Planning a troop program on an annual and a monthly basis is a new task for many leaders. Good planning and execution depend on (1) a Scoutmaster who understands the process, (2) trained youth leaders who can plan meetings and successfully execute them, (3) sufficient personnel in the form of assistant Scoutmasters and troop committee members, and (4) parents who are knowledgeable and informed.

Your first step in planning is to utilize the resources available to set goals for the troop. The next step is to train your youth leaders in the planning process. Then give them the responsibility and authority to plan and implement the troop program. The final step is to get your troop committee and parents to “buy in” to support this “Scout-planned” program.

The program planning guide in chapter 8 of the *Scoutmaster Handbook* will guide you through the basics of planning, from doing your homework to securing parental support for your program. The monthly troop program features found in *Scouting* magazine are the other principal resources needed to run the program planning workshop.

In addition, enhance the troop meeting by using games, Scoutmaster’s Minutes, ceremonies, and other support materials from the *Troop Program Resources for Scout Troops and Varsity Teams*, No. 33588.

## THE ANNUAL PLANNING PROCESS

The Scouting program year begins in September, so you should start troop planning during the summer. There are five basic steps in the annual process.

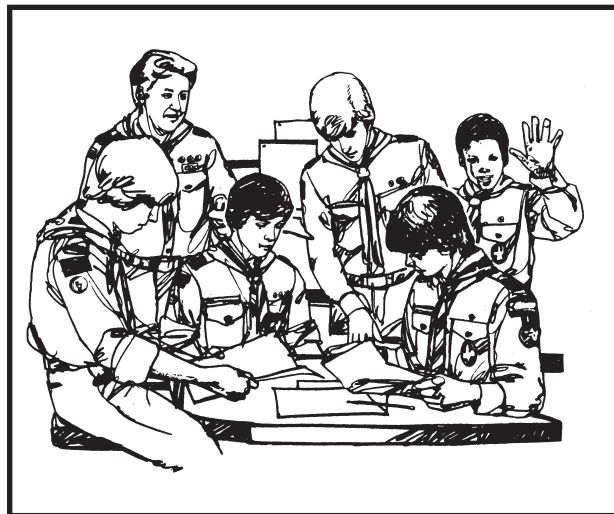

1. DO YOUR HOMEWORK.
2. GET PATROL INPUT.
3. CONDUCT THE ANNUAL TROOP PROGRAM PLANNING CONFERENCE.
4. OBTAIN TROOP COMMITTEE SUPPORT.
5. DISTRIBUTE INFORMATION.

## STEP 1: DO YOUR HOMEWORK

As Scoutmaster, you serve as the “advance” person. You check out and pull together certain things before your troop’s annual planning conference. Neither difficult nor time-consuming, the tasks listed below make a lot of sense because they pay off in a smoother, more effective conference, and they result in a better annual plan.

### **1. Gather district, council, community, and chartered organization dates for events that will affect the troop.**

Begin by picking up a calendar of key school dates from the local school. Check with the local chamber of commerce for dates of community activities. Don’t forget to

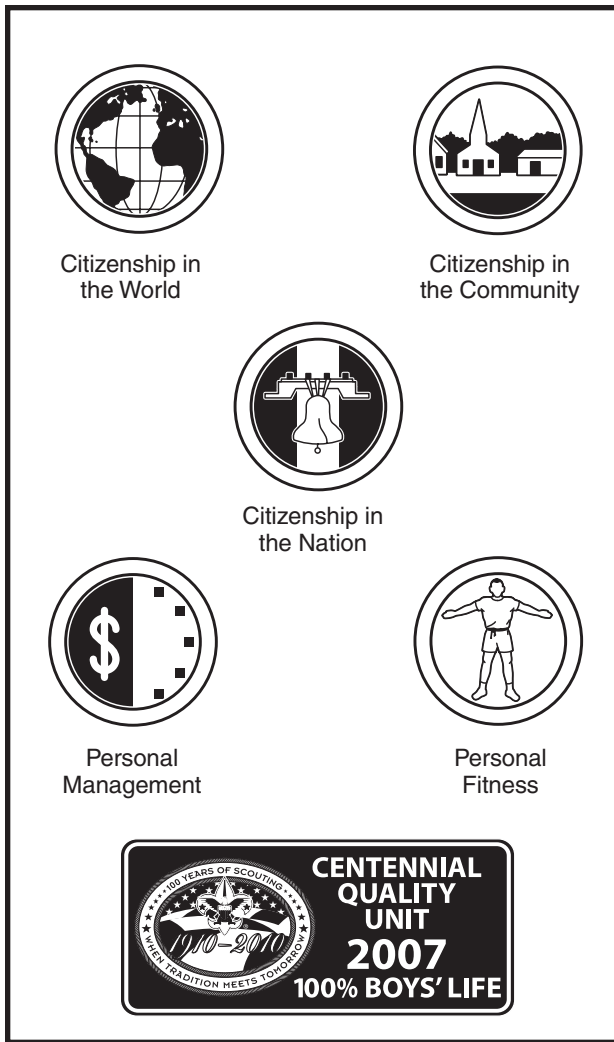

obtain dates of key chartered organization activities. Personal dates, such as anniversaries or birthdays, also may affect troop activities, so be sure to include those.

During the summer, be sure to attend the annual *council* or *district* program planning conference. This is where you will be able to get the council and district calendar, as well as information on activities, training courses, summer camp, etc.

Now put all these dates on one calendar to share with the troop committee and for use at the unit program planning conference.

## 2. Review the resources needed to plan the annual program.

Pull together your Scouting library. The items needed to plan your troop program include: *Troop Program Features* (Volume I, No. 33110; Volume II, No. 33111;

Volume III, No. 33112); issues of *Boys' Life* and *Scouting* magazines; program feature supplements from *Scouting* magazine; the *Scoutmaster Handbook*, No. 33009; the *Boy Scout Handbook*, No. 33105; the *Patrol Leader Handbook*, No. 32502; *Senior Patrol Leader Handbook*, No. 32501; and *Troop Program Resources for Scout Troops and Varsity Teams*, No. 33588.

## 3. Review the advancement status of each Scout.

Look carefully for basic skills needed by your Scouts and also for key merit badges that should be introduced through the troop program.

## 4. List some goals for the troop.

Take a look at successful areas from last year's program, like the number of Scouts who made First Class or the super Good Turn you did for your chartered organization. You probably will want to continue those things, but also consider some other challenges to address during the coming year. The list could get lengthy, so you may have to prioritize your choices, selecting only a few challenges for this year. After all, there is always next year. Here are some areas to consider:

- Centennial Quality Unit Award
- National Camping Award
- Service project or Good Turn
- Summer camp
- Special weekend events
- Troop membership growth
- Troop equipment
- Advancement

## 5. Review the program features available to the troop.

Using the Troop Program Planning Chart, list your suggestions for a program feature for each month of the coming year. Be sure to keep in mind the troop goals and advancement status of your Scouts. Share the list of program features with the senior patrol leader prior to presenting them to the patrol leaders' council. (*Hint:* List your program feature suggestions in *pencil* to emphasize that input is also expected from the senior patrol leader.)

## **6. Meet with the troop committee to review the calendar and potential troop goals.**

Share the calendar with the committee to ensure you haven't missed any important dates. Many committee members will be involved in troop activities, so they will want you to note any conflicts in their personal calendars.

Review the goals you have set for the troop. Now is the time the troop committee "buys in" to its role in making your troop successful. There will be a lot of discussion and some compromise, but the result will be a set of troop goals to which everyone feels committed.

Remember, these goals will not be finalized until after the youth leaders have also "bought in" at their annual planning conference.

## **7. Meet with your senior patrol leader to plan the next steps leading to the annual troop program planning conference.**

This can be time-consuming, and you may need more than one session. If so, devote the second meeting with the senior patrol leader to the sole task of mapping out the agenda for the troop planning conference.

You and the senior patrol leader should cover the following items at your meeting:

\_\_\_\_\_ Review the steps to planning an annual troop program.

\_\_\_\_\_ Review the calendar for any missing items.

\_\_\_\_\_ Discuss troop goals. Allow the senior patrol leader to have input; the only way to achieve the troop's objectives will be with everyone's help.

\_\_\_\_\_ Review the resources needed to plan the troop program.

\_\_\_\_\_ Discuss the program features suggested for the coming year.

\_\_\_\_\_ Discuss what major events and activities the troop might do during the coming year.

\_\_\_\_\_ Record these recommendations on the Troop Program Planning Chart for presentation to the patrol leaders' council.

\_\_\_\_\_ Discuss the presentation of this information at the patrol leaders' council meeting and the role of patrol leaders in the planning process.

\_\_\_\_\_ Set a date for the annual troop program planning conference.

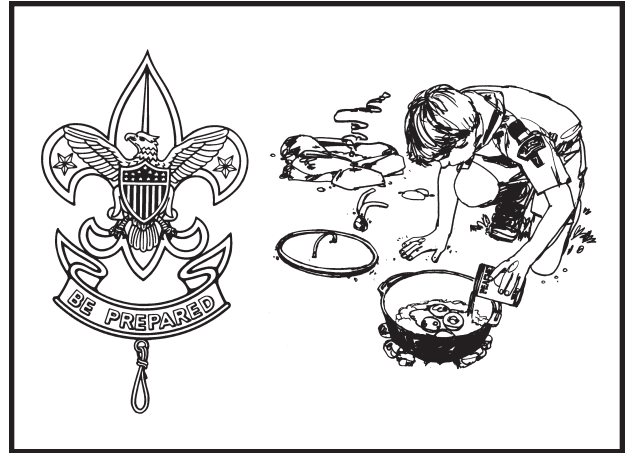

\_\_\_\_\_ Review the agenda and preparation needed to conduct the conference.

## **STEP 2: GET PATROL INPUT**

This second step in the annual planning process is where the senior patrol leader takes charge. At the next patrol leaders' council meeting, the senior patrol leader introduces the suggested annual troop plan. The patrol leaders need to understand that this is only a *proposed* program. The final program will be developed and voted on at the annual troop program planning conference.

Each patrol leader is asked to review this plan with his patrol members at the next troop meeting. The patrol leader should seek ideas from his patrol on what proposed programs they like or dislike and what additional programs they might be interested in.

The senior patrol leader then announces the date of the planning conference. He should briefly review the agenda and make assignments for physical arrangements, meals, etc.

## **STEP 3: CONDUCT THE ANNUAL PROGRAM PLANNING CONFERENCE**

This is the step where your troop program comes alive. The success of this conference began when you, the Scoutmaster, prepared your senior patrol leader. Be alert throughout the conference to help out the senior patrol leader. Don't wait for him to fail, but be careful not to take over for him. Careful, nonintrusive coaching will help your senior patrol leader build confidence. Share your leadership with him.

*Who attends the conference?* The troop's annual planning conference is attended by the Scoutmaster, assistant Scoutmaster for the new-Scout patrol, assistant Scoutmaster for the Venture patrol, senior patrol leader, assistant senior patrol leader, patrol leaders, and troop guide.

*Physical arrangements.* Careful planning should ensure that this planning conference is a first-class experience for your youth leaders. Pick a location that would be special to your Scouts, possibly one offering opportunities for other activities, such as swimming, boating, etc. You can make it a weekend experience, although the conference is easily completed in a day.

Whichever you do, don't involve the youth leaders in a lot of housekeeping chores that distract them from the primary purpose of planning the troop program. Consider using other troop adults to cook and clean up; let your patrol leaders' council concentrate on the task at hand.

Make sure the facilities are suited for a conference. Is ventilation good? Is there sufficient lighting? Are the chairs comfortable? Are there tables to work on? Is there a way to hang calendars on the wall? Use the checklist on page 9 to make sure your facilities will work.

Setting up the conference facility should have been previously assigned to members of the patrol leaders' council. A checkup by the senior patrol leader prior to the conference ensures that nothing is forgotten.

Follow the agenda. When directing a session, your senior patrol leader should be aware that it's easy to get sidetracked. If the group starts to drift away from the agenda, a gentle nudge from you may be in order to put them back on course.

Remember the conference ground rules:

1. THE SENIOR PATROL LEADER PRESIDES.
  2. EACH EVENT AND PROGRAM IS VOTED ON.
  3. THE MAJORITY RULES.

## **ANNUAL TROOP PROGRAM PLANNING CONFERENCE AGENDA**

(Note: No time limits have been placed on the agenda, but working sessions should last no longer than 45 minutes without a break.)

### **I. OPENING ACTIVITY** SCOUTMASTER

Conduct All Aboard or other team-building activity. This helps foster a spirit of working together to solve a common problem.

### **II. REVIEW CONFERENCE GROUND RULES**

SENIOR PATROL LEADER

#### A. Write down the conference objectives:

1. To decide on troop goals for the coming year
2. To develop a program that represents ideas from the entire troop

#### B. Review ground rules:

1. The senior patrol leader presides.
2. Each event and program is voted on.
3. The majority rules.

### **III. DEVELOP TROOP GOALS** SCOUTMASTER

A. The Scoutmaster leads a discussion on goals for the coming year. These could deal with such topics as advancement, service, or troop money earning. (These are the same goals discussed earlier with the troop committee and senior patrol leader.)

B. The patrol leaders' council votes to approve the goals.

### **IV. CONSIDER MAJOR EVENTS**

SENIOR PATROL LEADER

#### A. Review dates for items such as these:

1. Scouting shows
2. Camporees
3. Summer camp
4. Special troop events
5. Good Turn
6. Patrol suggestions for special activities

B. Vote on events. (Delete from the calendar any activities the troop will not participate in.)

C. Insert events on the Troop Program Planning Chart.

D. Backdate necessary preparation time for each event.



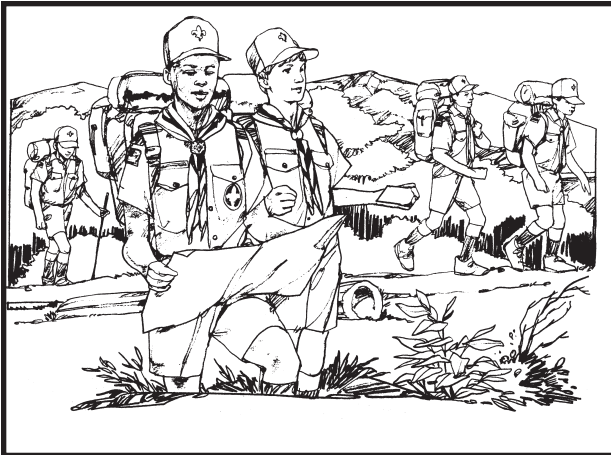

## ANNUAL TROOP PROGRAM PLANNING CONFERENCE CHECKLIST

### Literature

- Troop Program Features, Volume I*, No. 33110
- Troop Program Features, Volume II*, No. 33111
- Troop Program Features, Volume III*, No. 33112
- Troop Program Resources for Scout Troops and Varsity Teams*, No. 33588
- Scoutmaster Handbook*, No. 33009
- Boy Scout Handbook*, No. 33105
- Patrol Leader Handbook*, No. 32502
- Senior Patrol Leader Handbook*, No. 32501
- Program features from *Scouting* magazine
- Scouting* magazines
- Boys' Life* magazines
- Troop Program Planning Chart
- District/council calendar
- School calendar
- Chartered organization calendar
- Community calendar
- Information on council and district events
- Complete copy of next month's program feature, for the final part of the workshop (one per participant)
- Troop Resource Surveys completed by parents and troop leadership
- Troop/Team Record Book, No. 34510
- Troop Advancement Chart, No. 34506

### Program Supplies

- All Aboard activity (supplies needed)
- Game (supplies needed)
- Flip-chart stand and pad(s)
- Twelve large calendar pages
- Felt-tip markers
- Writing pads for participants
- Pens or pencils
- Thumbtacks
- Masking tape
- Extension cord

### Food/Refreshments

- Refreshments for morning and afternoon breaks
- Additional food (lunch, etc.)

### Conference Facility Setup

- Tables set in horseshoe or square, depending on number of people
- Flip-chart stand placed for easy viewing and use
- Calendar pages hung on wall
- Troop Program Planning Chart hung at front center of room
- Table at front of room for resource material

### V. GAME BREAK

### VI. DISCUSS PATROL SUGGESTIONS FOR PROGRAM FEATURES

- A. Discuss the program features suggested for the coming year.
- B. Will they meet the goals of the troop?
- C. What are the advancement opportunities?
- D. Decide where program features best fit into the calendar.
- E. Vote on the final list of program features.
- F. Insert the approved features into the Troop Program Planning Chart.

### VII. LUNCH OR GAME BREAK

### VIII. SCHEDULE SPECIAL TROOP ACTIVITIES

- A. Decide on a schedule for the following:
  1. Board of review
  2. Courts of honor
  3. Recruitment night(s)
  4. Webelos Scout graduation
- B. Add these dates to the Troop Program Planning Chart.

### IX. FINALIZE THE TROOP PLANNING WORKSHEET

Put the Troop Program Planning Chart into final form for presentation to the troop committee.

### X. GAME BREAK

### XI. MONTHLY PROGRAM PLANNING

Plan next month's program.

### XII. SCOUTMASTER'S MINUTE

# TROOP PROGRAM

MONTH	PROGRAM FEATURES			TROOP OUTDOOR/ CAMPING ACTIVITY	DISTRICT/ COUNCIL ACTIVITY	
	NEW-SCOUT PATROL	EXPERIENCED PATROLS	VENTURE PATROL			
SEPT.						
OCT.						
NOV.						
DEC.						
JAN.						
FEB.						
MAR.						
APR.						
MAY						
JUNE						
JULY						
AUG.						





### Conference Assignments

- \_\_\_\_\_ Develop menus and purchase food.
- \_\_\_\_\_ Prepare food and clean up.
- \_\_\_\_\_ Gather supplies (see checklist).
- \_\_\_\_\_ Set up conference facility.
- \_\_\_\_\_ Prepare large blank calendars with months, days, and known dates.
- \_\_\_\_\_ Prepare flip chart with conference objectives and ground rules.
- \_\_\_\_\_ Prepare Troop Program Planning Chart with correct months.

## STEP 4: OBTAIN TROOP COMMITTEE SUPPORT

At the completion of the annual troop program planning conference, you and your senior patrol leader should prepare a clean draft of the Troop Program Planning Chart for presentation to the troop committee. Arrange with the committee chairman for this important topic to be placed on the meeting agenda. Then you and the senior patrol leader present the troop's annual program to the committee.

Try to anticipate questions and prepare your senior patrol leader to answer them. (Remember, it's a Scout-planned program.) The critical question the committee must resolve is: Does the troop have the resources to carry out this program? If not, can the resources be obtained, and are the troop members willing to do their share in obtaining these resources?

There may be need for compromise. In those cases, the senior patrol leader should present the options to the patrol leaders' council for its approval.

The finished product from these discussions will be a troop program that is accepted by everyone and has the necessary support to make it work.

## STEP 5: DISTRIBUTE INFORMATION

Now that you have a great troop program planned, don't keep it a secret, share it with everyone.

The best way to do it is at a parents' night program. Have some good fun and fellowship, and then share the troop's plan for the year. Let the Scouts announce the plan, but let the troop committee talk about what kinds of help will be needed from parents to make the program work.

This is the final phase of the buy-in talked about earlier. Here is where you get those extra hands for the garage sale, transportation for outings, and maybe even a consultant for Venturing.

Ask a computer whiz in the troop to design an original troop calendar. Give everyone a copy. (If it is nice enough, troop families may use it to record all their family activities.)

Don't stop the sharing at the troop level. Make sure the chartered organization and your unit commissioner have a copy of your troop's plans. Develop a news article for the local newspaper, highlighting the special activities the troop has planned for the coming year. Some potential Scouting parent might read it and be inspired to join your troop.

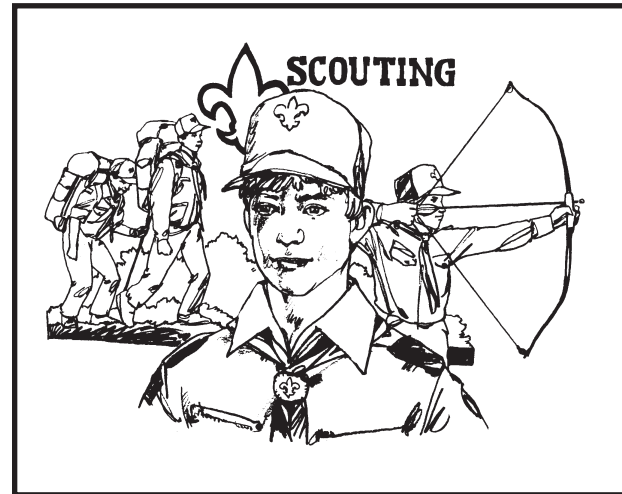

## PLANNING THE MONTHLY TROOP PROGRAM

Developing an annual plan is really just the first step in planning the troop program. On a quarterly basis, the patrol leaders' council should review the annual plan and make any adjustments necessary to ensure the smooth implementation of all programs. These quarterly checkpoints are also important because some programs require more than a month to plan.

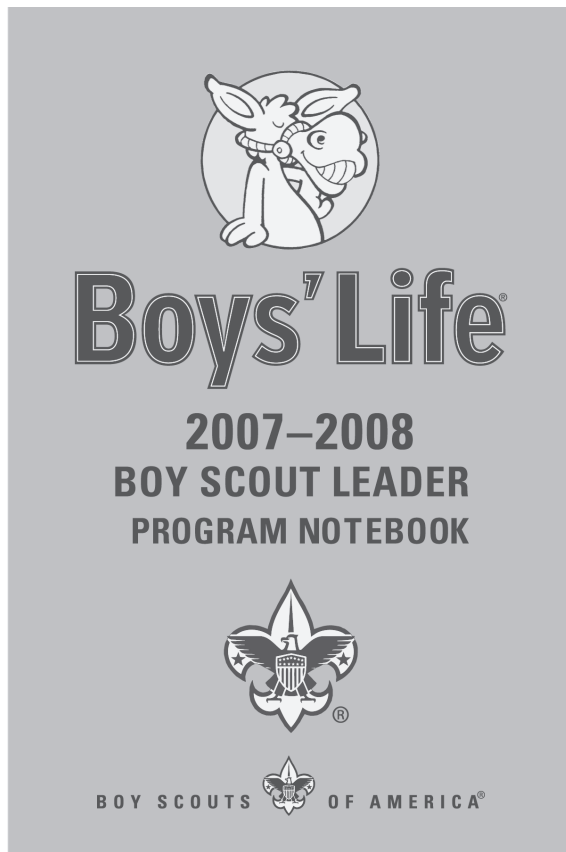

As a part of the annual program planning conference, you are asked to plan the next month's troop program. Even if your troop is very experienced, this session should be used to teach your youth leaders to use the troop program features found in *Scouting* magazine. Once they are comfortable in using these, you can give them the option of adding flexibility to the program. But be careful. (Too much departure from the suggested troop meeting activities could result in less exciting meetings and poor advancement.)

Each program feature provides detailed information on four weekly meetings, a monthly highlight activity, advancement requirements that can be satisfied, and some good skills suggestions.

Activities incorporating all basic and intermediate skills your Scouts need for the monthly program are woven into each weekly meeting. Detailed use of program features will ensure regular advancement of your Scouts and provide troop meetings that are fun and exciting, not dull and boring.

## YOUR PROGRAM ASSISTANTS

Besides offering their readers entertaining, well-written fare, *Boys' Life* and *Scouting* magazines support the nationally suggested Boy Scout troop program features. In each monthly issue, *Boys' Life* provides ideas and inspiration to Scouts about how they can enjoy the BSA-suggested program for the following month. *Scouting* provides adult leaders similar tools to strengthen the BSA program with special articles about packs and troops that have used the monthly program feature successfully.

In addition, five of the six issues of *Scouting* magazine contain a total of 12 segments called "troop program features." These represent one-third of the 36 monthly features found in *Troop Program Features (Volume I, No. 33110; Volume II, No. 33111; and Volume III, No. 33112)*. Another program tool, Boy Scout Leader Program Notebook, is a pocket-size publication that contains space to jot down ideas and plans for troop activities. It is available at your BSA local council service center.

## WEEKLY MEETING PLAN

Each program feature includes four weekly troop meeting plans that can be used to plan activities in detail. The blank chart shown on the next page is an example.

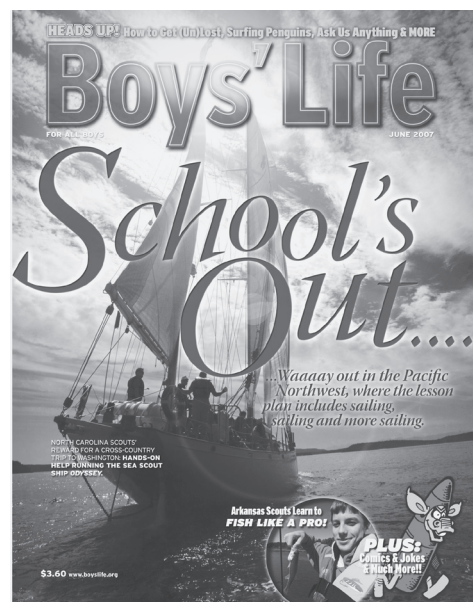

## TROOP MEETING PLAN

Date \_\_\_\_\_

ACTIVITY	DESCRIPTION	RUN BY	TIME
<b>Preopening</b> _____ minutes			
<b>Opening Ceremony</b> _____ minutes			
<b>Skills Instruction</b> _____ minutes			
<b>Patrol Meetings</b> _____ minutes			
<b>Interpatrol Activity</b> _____ minutes			
<b>Closing</b> _____ minutes Total 90 minutes of meeting	<ul style="list-style-type: none"> <li>• Scoutmaster's Minute.</li> </ul>	SM	
<b>After the Meeting</b>			

## AQUATICS

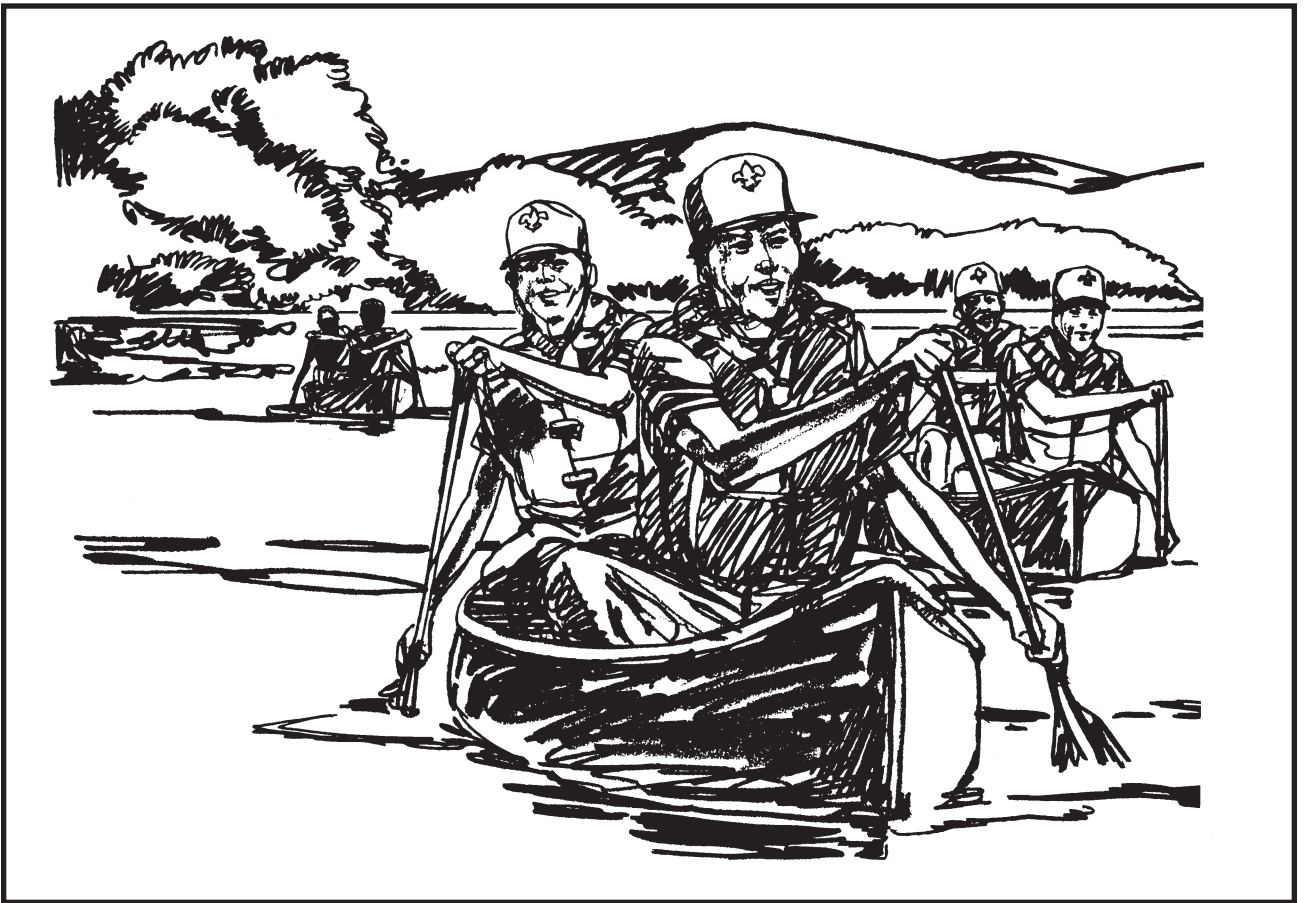

In any camp where a waterfront is within a half-mile, Scouts will gravitate there like bees to honey. Most Scouts like nothing better than a swimming session or a couple of hours in canoes or boats.

In this program feature we will capitalize on that interest by providing a month of fun and, at the same time, encouraging the boys to become stronger swimmers and better boaters and canoeists.

If possible, hold all troop activities this month at a waterfront or swimming pool. The troop meeting plan for this month suggests both water activities and alternatives to use if you must meet at your regular meeting place.

If the troop does not have access to a waterfront or pool, ask for help from your unit commissioner or district activities committee. They might suggest municipal pools, facilities at a YMCA or YMHA (Young Men's Hebrew Association), or even school or motel pools that could be used. For these facilities, you will probably have to hold troop activities in off-hours.

At a minimum, the troop's goal should be to have all Scouts advance from the nonswimmer class by month's end. If most of your Scouts are already good swimmers, urge them to work toward the merit badges

in swimming, lifesaving, and aquatic sports, and the Snorkeling, Mile Swim, BSA, and BSA Lifeguard awards.

The big event will be a water show for the troop's families or a water expedition with canoes or rafts. The patrol leaders' council's choice of events for the show will depend on how many Scouts have earned the swimmer designation.

### SCOUTING OUTCOMES

This month's patrol and troop activities should give your Scouts

- A better understanding of physical fitness
- Greater swimming skills, and perhaps greater skill in handling canoes, boats, or other watercraft
- Enhanced self-confidence

### ADVANCEMENT OPPORTUNITIES

By month's end, all Scouts should have met the majority of their physical fitness requirements through First Class rank. Depending on the activities, they may also complete all or part of the following rank requirements:

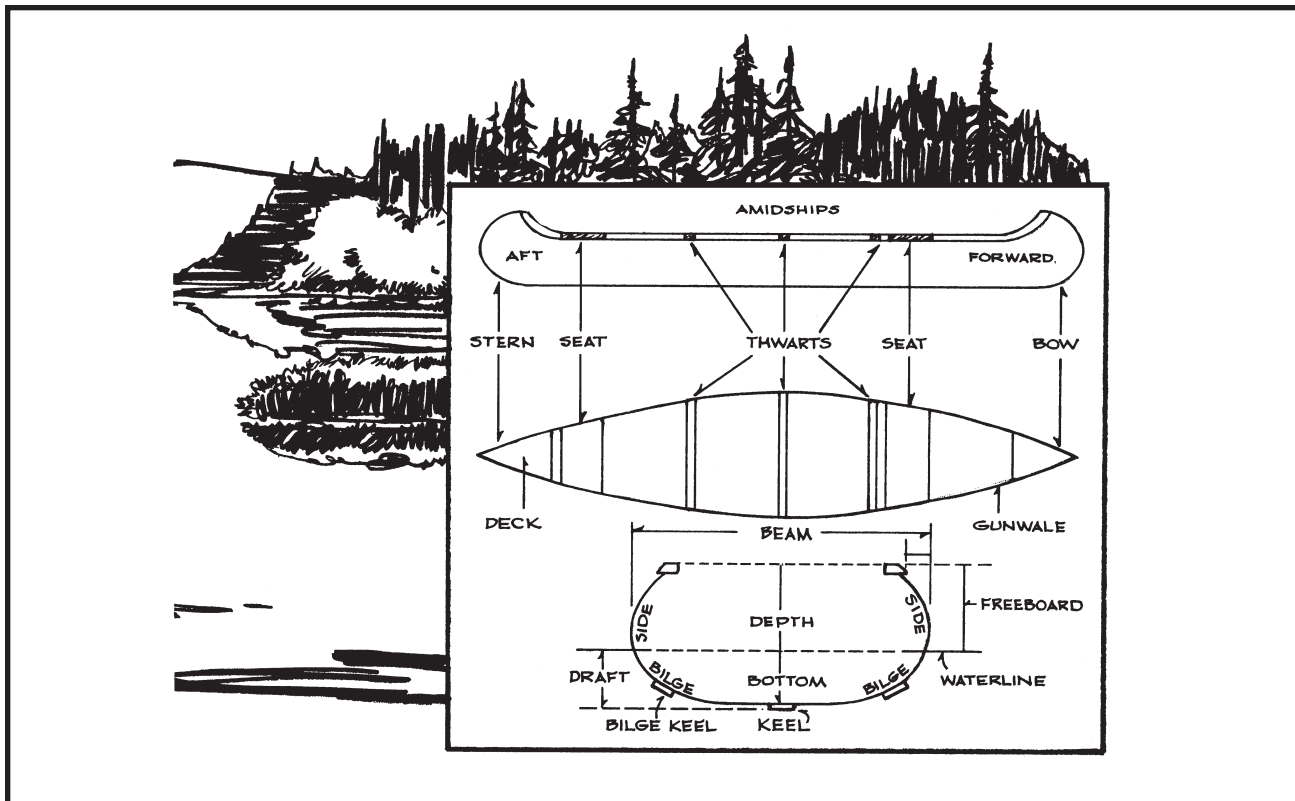

### *Tenderfoot*

- Patrol/troop participation—patrol identification
- Personal development—Scout Oath and Law
- Physical fitness—health, conditioning, swimming

### *Second Class*

- Patrol/troop participation—leadership
- Personal development—Scout Oath and Law
- Physical fitness—health, conditioning, swimming

### *First Class*

- Patrol/troop participation—leadership
- Personal development—Scout Oath and Law
- Physical fitness—health, conditioning, swimming

*Merit Badges.* Older Scouts can concentrate on the Swimming merit badge this month; they should be able to complete many of the requirements. Depending on activities during the month, they may also complete requirements in Lifesaving, and if the facilities permit, other aquatic-related merit badges such as Canoeing, Rowing, and Small-Boat Sailing.

## **PARENT/GUARDIAN PARTICIPATION**

The patrol leaders' council can involve parents in the program feature this month by

- Asking qualified parents to assist with swimming instruction
- Inviting parents to come along on the water expedition
- Inviting the whole family to your water show

## **PATROL LEADERS' COUNCIL**

The patrol leaders' council should meet during the early part of the previous month to plan troop activities for this program feature. If you don't complete all items on the following agenda, continue your planning at patrol leaders' council meetings after each troop meeting.

- Older boys may want to plan a canoe trip at one of the BSA's high-adventure bases.
- Decide whether to make the big event a water expedition or water show. Remember that for a canoe or raft trip, only Scouts who have been classified as "swimmers" are eligible to go, since the BSA Safety Afloat plan bars nonswimmers from all watercraft except rowboats and motorboats. So, if many of your Scouts cannot be expected to earn the swimmer designation before the big event, better plan for a water show. See the ideas on these pages.



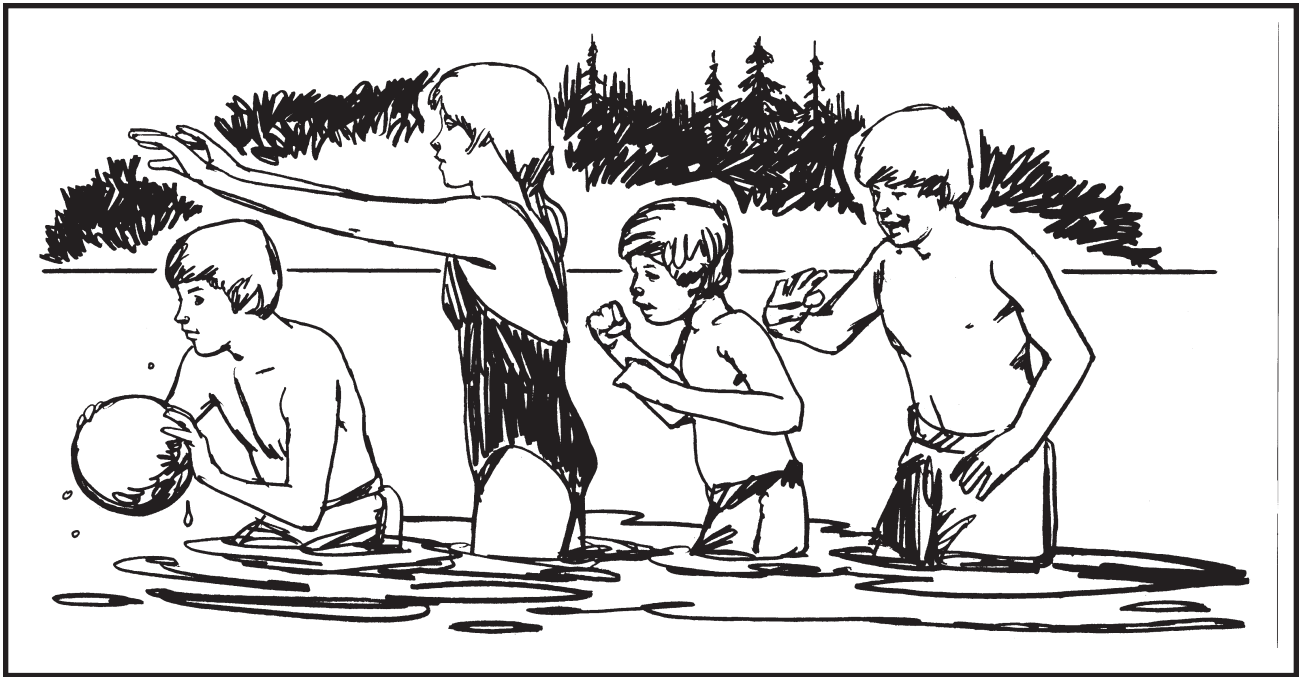

- Choose a site or watercourse for the big event. Assign someone to secure the necessary permissions; ask the troop committee for help, if necessary.
- If the big event will be an expedition, arrange to borrow or rent equipment. (Some BSA local councils will rent canoes.)
- If possible, arrange to secure a waterfront or pool for all troop activities. (Remember that it may be necessary to change regular meeting dates or hours to use these facilities.)
- Plan the details of troop meetings for the month. Consider inviting Swimming merit badge counselors to help with swimming instruction. You might also ask counselors for other aquatics merit badges to help, depending on available facilities and equipment.

## FEATURE EVENT

### Water Show or Expedition

The patrol leaders' council should plan the big event based on the swimming ability and desires of the Scouts. The patrol leaders' council will probably prefer a water expedition, such as a canoe or raft trip, but only those classified as swimmers will be eligible to go.

If the troop has a lot of nonswimmers or beginners, it is best to have a water show—or have both events, with only swimmers taking part in the expedition.

### Water Show

This is a day of water fun and water safety demonstrations for the whole family. It could be held at a

swimming pool or at a waterfront. If it is held at a waterfront and canoes and boats are available, the program can be more varied. The day might end with a troop family picnic and campfire.

The following are some suggested activities.

**SAFE SWIM DEFENSE.** Remember to use this for all swimming activities. Demonstrate the Safe Swim Defense and explain its value for safety. Prior planning is needed for any swimming or boating activity. It is required that at least one adult must be certified in Safe Swim Defense and/or Safety Afloat, which also requires CPR from any community agency. See the *Scoutmaster Handbook*.

**RESCUE BREATHING.** Have a patrol demonstrate rescue breathing and invite family members to try it.

**CANDY HUNT (for Scouts and their brothers and sisters).** Drop a number of foil-wrapped hard candies into the water at chest level. On signal, children jump in and retrieve as many pieces as they can.

**WATER RESCUES.** Have a patrol demonstrate the Reach, Throw, and Go With Support methods of water rescue (*Boy Scout Handbook*).

**NAIL-DRIVING UNDERWATER (for parents).** Have a hammer, five nails, and a piece of 2-by-4 for each parent. The object is to go underwater with the block, nails, and hammer, and pound as many nails as possible within a specified period—say, three minutes. Obviously, your parent can come up for air between strokes.

**LIFESAVING WITH CANOE.** Have a patrol demonstrate how to right a capsized canoe and how to save a struggling swimmer using a canoe. See the *Canoeing* merit badge pamphlet.

**MOTHER-DAUGHTER/SON BALLOON TOSS.** Each mother-daughter/son team is given a balloon filled half-way with water. Partners face each other about 10 feet apart in the water and begin tossing the balloon back and forth. After each catch, the thrower takes one step backward. When a player misses, the team is eliminated. The team with the most successful tosses wins.

### **Patrol Relays**

Run swimming relay races in chest-deep water so that nonswimmers can take part by walking their lap.

**UP AND UNDER (for Scouts and brothers and sisters).** Have a volleyball or beach ball for each team. All teams line up relay fashion in waist-deep water. The first player in each line is given the ball. On signal, he passes the ball back over his head to the next player in line, who passes it between his legs to the next player, and so on to the end of the line. The last player runs to the head of the line and passes it as before. The first team back in its original order wins.

**GREASED WATERMELON (for Scouts and older brothers and sisters).** Divide players into two teams. Have each team form two lines about 15 feet from the center of the pool or playing area. In the center, float a medium-sized watermelon greased with shortening. On signal, each team tries to bring the watermelon to its starting line. The successful team gets first crack at the melon when it's time to eat.

**BIG BLOW (for Scouts and brothers and sisters).** Play this game in chest-deep water. Each team lines up, relay fashion, and is given a table tennis ball or toy boat. On signal, the first player on each team swims or walks to a turning line and back while blowing the ball or boat ahead of him. The following players repeat the action. The first team to finish wins.

For more swimming contests, see the Games section of *Troop Program Resources for Scout Troops and Varsity Teams*, No. 33588.

### **Water Expedition**

A day or weekend trip in canoes or rafts is a great adventure for Scouts, but it is not for everyone. Do not permit any nonswimmer or beginner to make the trip.

Also insist that a U.S. Coast Guard-approved PFD (personal flotation device) be worn by every participant. Enforce the Safety Afloat guidelines as explained in the *Scoutmaster Handbook*.

Unless all participants—both Scouts and leaders—are experienced canoeists or rafters, hold at least one practice session before the big trip. This is especially important if it is an overnighter and troop members will be carrying packs and other equipment in their craft.

Consider the capabilities of all participants in choosing a river or other watercourse. If all are inexperienced, avoid difficult courses with white water. Save those for Scouts who have earned the Canoeing merit badge.

If you plan an overnight camp en route, you might arrange to have Scouts who are not eligible to go on the trip join you at the campsite so that they can take part in the fun.

Start your planning for a water expedition by reading “Swimming Skill and Safety” in the *Canoeing* merit badge pamphlet. That section tells how to prepare for a safe, enjoyable expedition.

### **Special Aquatics Awards**

Scouts who are already good swimmers may begin to work toward any of four special awards this month. Although these are not advancement awards, they will encourage Scouts to improve their skills and have some additional fun. The awards are:

*Mile Swim, BSA.* The requirements call for the Scout to swim a mile over a measured course after four hours of training and to know safety rules for swimming in open water.

*Snorkeling, BSA.* The requirements call for the Scout to demonstrate the use of a mask, fins, and a snorkel in deep water, to know diver's signs and signals, and to understand hyperventilation and hypothermia. The full requirements are outlined in the Application for Snorkeling, BSA, No. 19-176.

*BSA Lifeguard.* The requirements call for the Scout to know the requirements for the Swimming, Lifesaving, Rowing, Canoeing, and First Aid merit badges, the Safe Swim Defense, and Safety Afloat, and be able to demonstrate specific skills. The full requirements are outlined in the Application for BSA Lifeguard, No. 34435.

*50-Miler Award.* Scouts are eligible for this award if they take part in a canoe or boat trip (or wilderness trek) of at least 50 consecutive miles in at least five days and do conservation work en route. The full requirements are outlined in the 50-Miler Award Application, No. 34408.

*Boardsailing, BSA.* Scouts are introduced to basic boardsailing skills, equipment, and safety precautions and will build a knowledge foundation for participation in more advanced and demanding activities on the water. The full requirements are outlined in the Boardsailing, BSA Award Application, No. 19-935A.

# AQUATICS

## TROOP MEETING PLAN

Date \_\_\_\_\_ Week 1

ACTIVITY	DESCRIPTION	RUN BY	TIME
<b>Preopening</b> _____ minutes	Meet at the waterfront or pool, if possible. Set up the Safe Swim Defense ( <i>Boy Scout Handbook</i> ). If the meeting is held at your meeting place, make buddy tags ( <i>Swimming</i> merit badge pamphlet).		
<b>Opening Ceremony</b> _____ minutes	Test the swimming ability of all Scouts and classify each as a nonswimmer, beginner, or swimmer. Pair up buddies. Have instruction for nonswimmers.		
<b>Skills Instruction</b> _____ minutes	<ul style="list-style-type: none"> <li>• New Scouts can begin working on strokes that are needed for Second and First Class ranks.</li> <li>• Experienced Scouts can work on the Lifesaving or Swimming merit badges.</li> <li>• Older Scouts can work on the Venture program or on Snorkeling, BSA; BSA Lifeguard; Mile Swim, BSA; or assist with the instruction of less experienced Scouts.</li> </ul>		
<b>Patrol Meetings</b> _____ minutes	Schedule a patrol practice for the water show. Work with nonswimmers on swimming skills.		
<b>Interpatrol Activity</b> _____ minutes	Practice one of the events for the water show.		
<b>Closing</b> _____ minutes Total 90 minutes of meeting	<ul style="list-style-type: none"> <li>• Scoutmaster's Minute.</li> <li>• Retire colors.</li> </ul>	SM	
<b>After the Meeting</b>	Patrol leaders' council reviews the next meeting and plans for the water show. Begin work on next month's program feature.		

# AQUATICS

## TROOP MEETING PLAN

Date \_\_\_\_\_ Week 2

ACTIVITY	DESCRIPTION	RUN BY	TIME
<b>Preopening</b> _____ minutes			
<b>Opening Ceremony</b> _____ minutes			
<b>Skills Instruction</b> _____ minutes	<ul style="list-style-type: none"> <li>• New Scouts continue working on strokes that are needed for Tenderfoot through First Class ranks.</li> <li>• Experienced Scouts continue work on the Lifesaving or Swimming merit badges.</li> <li>• Older Scouts work on the Venture program or on Snorkeling, BSA; BSA Lifeguard; Mile Swim, BSA; or assist with the instruction of less experienced Scouts.</li> </ul>		
<b>Patrol Meetings</b> _____ minutes	Continue work on swimming skills.		
<b>Interpatrol Activity</b> _____ minutes			
<b>Closing</b> _____ minutes Total 90 minutes of meeting	<ul style="list-style-type: none"> <li>• Scoutmaster's Minute.</li> <li>• Retire colors.</li> </ul>	SM	
<b>After the Meeting</b>	Patrol leaders' council reviews the next meeting and plans for the water show. Continue work on next month's program feature.		

# AQUATICS

## TROOP MEETING PLAN

Date \_\_\_\_\_ Week 3

ACTIVITY	DESCRIPTION	RUN BY	TIME
<b>Preopening</b> _____ minutes			
<b>Opening Ceremony</b> _____ minutes			
<b>Skills Instruction</b> _____ minutes	<ul style="list-style-type: none"> <li>• New Scouts continue working on strokes that are needed for Tenderfoot through First Class ranks.</li> <li>• Experienced Scouts continue work on the Lifesaving or Swimming merit badges.</li> <li>• Older Scouts work on the Venture program or on Snorkeling, BSA; BSA Lifeguard; Mile Swim, BSA; or assist with the instruction of less experienced Scouts.</li> </ul>		
<b>Patrol Meetings</b> _____ minutes	Continue work on swimming skills.		
<b>Interpatrol Activity</b> _____ minutes			
<b>Closing</b> _____ minutes Total 90 minutes of meeting	<ul style="list-style-type: none"> <li>• Scoutmaster's Minute.</li> <li>• Retire colors.</li> </ul>	SM	
<b>After the Meeting</b>	Patrol leaders' council reviews the next meeting and plans for the water show. Continue work on next month's program feature.		

# AQUATICS

## TROOP MEETING PLAN

Date \_\_\_\_\_ Week 4

ACTIVITY	DESCRIPTION	RUN BY	TIME
<b>Preopening</b> _____ minutes			
<b>Opening Ceremony</b> _____ minutes			
<b>Skills Instruction</b> _____ minutes	<ul style="list-style-type: none"> <li>• New Scouts continue working on strokes that are needed for Tenderfoot through First Class ranks.</li> <li>• Experienced Scouts continue work on the Lifesaving or Swimming merit badges.</li> <li>• Older Scouts work on the Venture program or work on Snorkeling, BSA; BSA Lifeguard; Mile Swim, BSA; or assist with the instruction of less experienced Scouts.</li> </ul>		
<b>Patrol Meetings</b> _____ minutes	Continue work on swimming skills.		
<b>Interpatrol Activity</b> _____ minutes			
<b>Closing</b> _____ minutes Total 90 minutes of meeting	<ul style="list-style-type: none"> <li>• Scoutmaster's Minute—reflection on the experiences of the month.</li> <li>• Retire colors.</li> </ul>	SM	
<b>After the Meeting</b>	Patrol leaders' council reviews the next meeting and checks last-minute details for the water show. Finalize work on next month's program feature.		

# AQUATICS

## TROOP OUTDOOR PROGRAM PLAN

**Date** \_\_\_\_\_

TIME	ACTIVITY	RUN BY
Saturday 9:00 A.M.	Arrive at pool or swimming area, set up equipment.	SPL/PLC
9:30 A.M.	Rest of troop arrives.	
10:00 A.M.	Aquatic activities begin.	
Noon	Sack lunch	
1:30 P.M.	Continue aquatic activities.	
3:30 P.M.	Family swim	
4:30 P.M.	Present awards, leave for home.	





# ATHLETICS

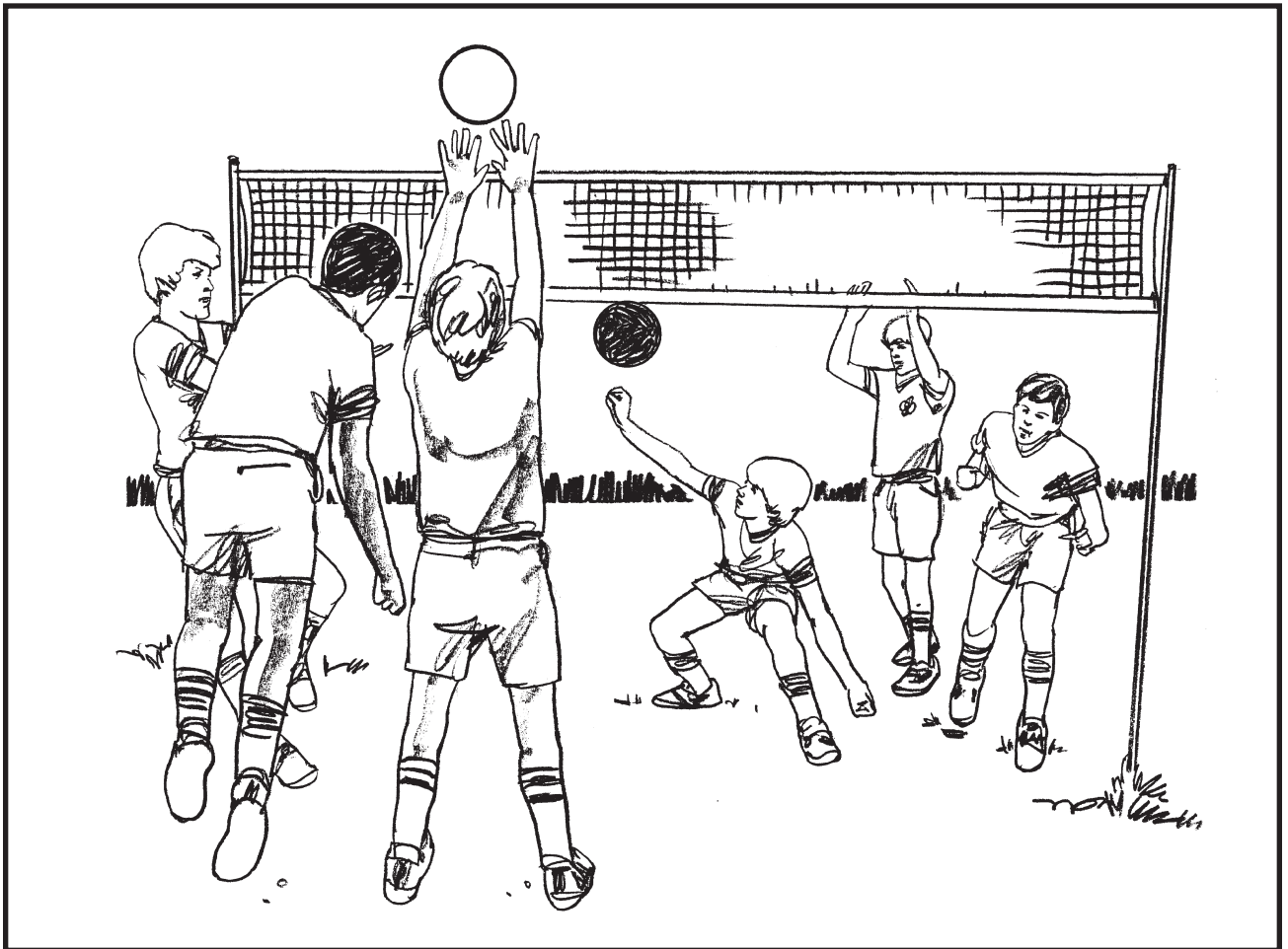

Physical fitness has always been one of the aims of the Boy Scouts of America, so this program feature is right on target. Our objective in athletics is not to produce super athletes but to promote fitness; to encourage Scouts to make steady improvement in strength, coordination, and agility; and, of course, to have fun.

Troop meetings will include plenty of physical activity, as well as some instruction on the importance of good nutrition and abstinence from smoking, alcohol, and other drugs.

The big event will be a field day with various types of athletic competition. The patrol leaders' council may want to arrange for an intertroop competition by inviting other troops. The objective should be physical fitness and fun, not just winning. The field day can be a one-day event or the highlight of a weekend campout; ideas for both are included on these pages.

## SCOUTING OUTCOMES

This month's patrol and troop activities should give your Scouts

- A greater understanding that physical fitness is essential for a fulfilling life
- An awareness that they can improve their fitness with regular exercise, adequate diet and rest, and abstinence from smoking, drugs, and alcohol
- Enhanced self-confidence as a result of improved physical fitness
- Practice in teamwork and decision-making
- An appreciation for the concentration that top athletes require

## ADVANCEMENT OPPORTUNITIES

By month's end, all Scouts should have completed most of the basic camping and cooking requirements through

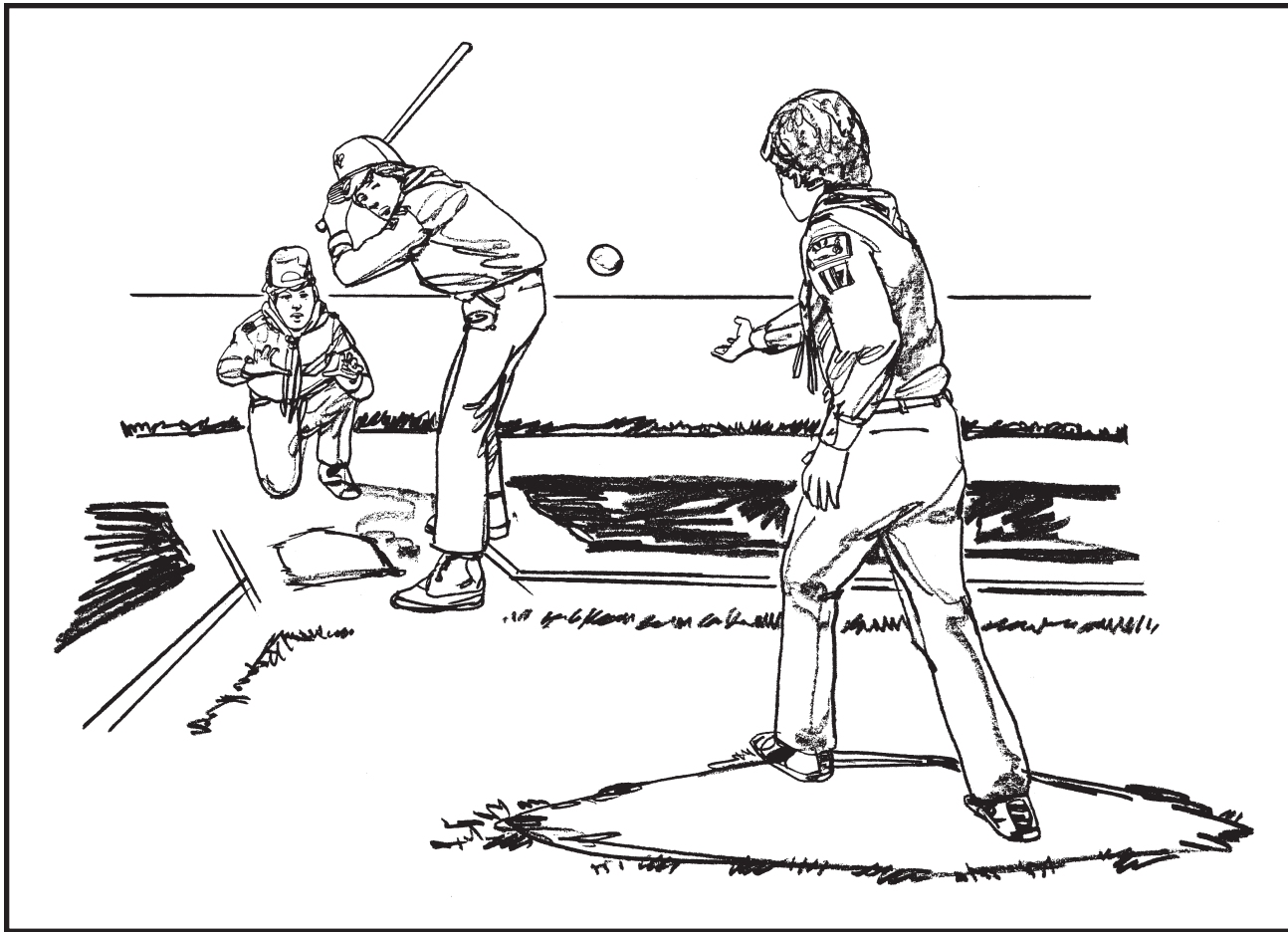

First Class rank. Depending on the campout activities, they may also complete all or part of the following rank requirements:

*Tenderfoot*

- Outdoor—hiking, camping
- Citizenship—flag ceremonies
- Patrol/troop participation—patrol identification
- Personal development—Scout Oath and Law
- Physical fitness—health, conditioning

*Second Class*

- Outdoor—camping, hiking
- Citizenship—flag ceremonies
- Patrol/troop participation—patrol identification
- Personal development—Scout Oath and Law
- Physical fitness—health, conditioning, drug awareness

*First Class*

- Outdoor—cooking, camping, nature, hiking
- Citizenship—flag ceremonies

- Patrol/troop participation—patrol identification
- Personal development—Scout Oath and Law
- Physical fitness—health, conditioning, drug awareness

*Merit Badges.* Older Scouts can concentrate on the Athletics merit badge this month and should be able to complete many of the requirements. Depending on activities during the month, they may also cover requirements in Camping, Cooking, Cycling, Hiking, Skating, Skiing, Sports, Swimming, and other outdoor-related merit badges.

**PARENT/GUARDIAN PARTICIPATION**

The patrol leaders' council can involve parents in the program feature this month by

- Asking qualified parents to serve as judges, scorers, timekeepers, etc.
- Inviting families to the outing
- Asking parents to provide transportation to the outing site
- Recruiting parents to coach specific sports

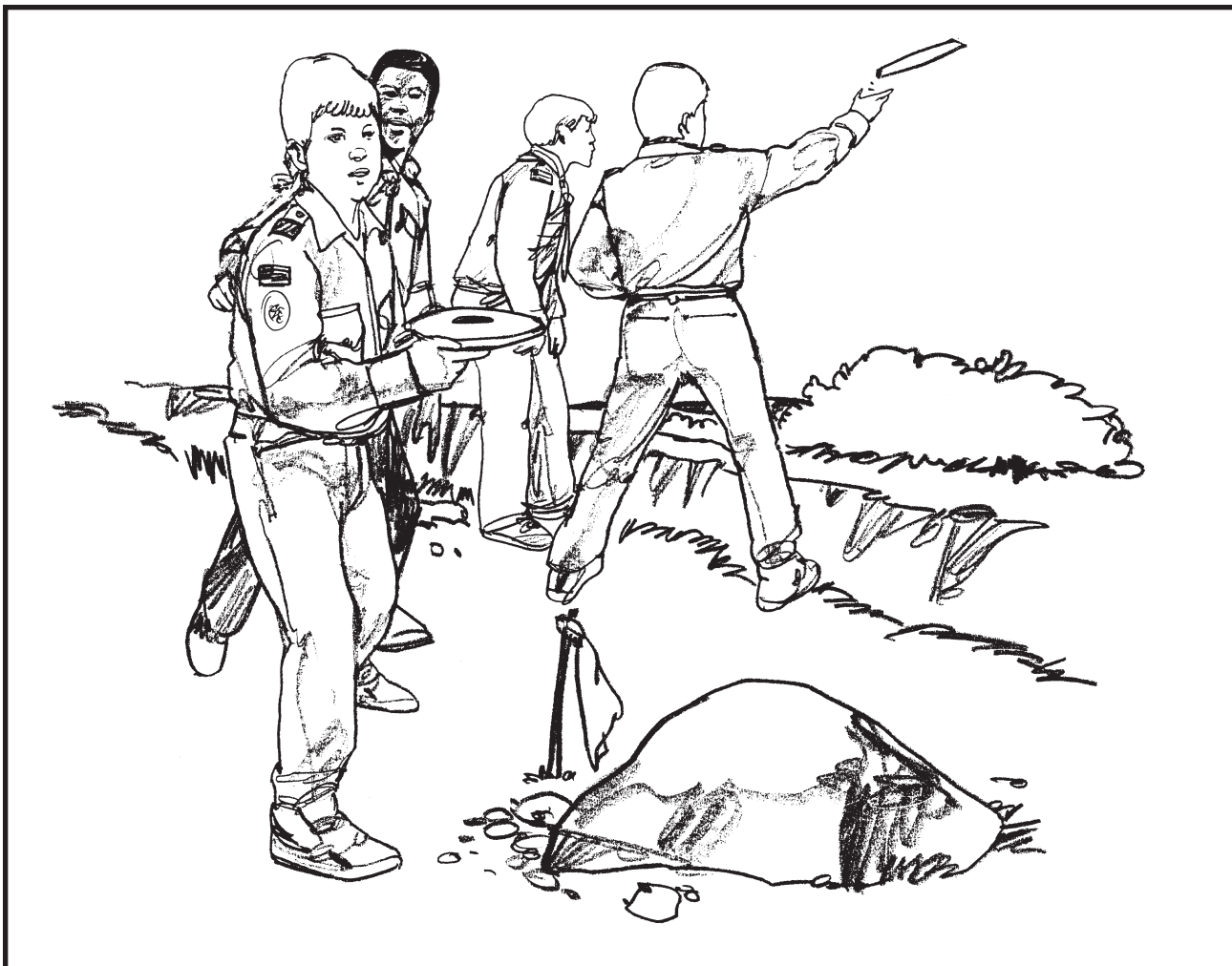

### **PATROL LEADERS' COUNCIL**

The patrol leaders' council should meet during the early part of the previous month to plan troop activities for this program feature. If you don't complete all items on the following agenda, continue your planning at patrol leaders' council meetings after each troop meeting.

- Decide whether to make the field day a one-day event or the highlight of a weekend campout. Choose a site for the field day and secure permissions if needed.
- Plan the events for the field day. See the ideas on the following pages.
- Secure the necessary equipment; ask the troop committee for help, if necessary.
- Determine if you want to hold the outing in conjunction with other troops; if so, invite them.
- Plan the details of troop meetings for the month. Consider inviting counselors for the Personal Fitness or Athletics merit badge to help with instruction.

- Make a list of possible patrol Good Turns to perform for the community.
- Coordinate any intertroop competitions.

### **FEATURE EVENT**

#### **Athletics Field Day**

Here are some possible events for your field day.

**FRISBEE GOLF.** Lay out a 9- or 18-hole course. The "holes" are trees, small buildings, large rocks, patrol flags, etc. Mark each one with a colored cloth. Make the course challenging by using such "hazards" as ravines, streams, and slopes. Players count their strokes from "tee" to "hole" as in real golf.

Divide Scouts into foursomes or twosomes. The team with the lowest score gets 100 points for its total team score, or set some other value.

**Variation:** Make it a speed contest. The winning team is the one that finishes with the fastest time, regardless of the number of strokes.

**OBSTACLE COURSE.** Use both serious and fun obstacles. Time each runner. Set point values for first, second, and third place, etc.

**DOUBLE ACTION VOLLEYBALL.** Have two balls in play simultaneously. (If possible, have different colored balls.) A point is not awarded until both balls are dead. Play 5- or 10-point games for faster action.

**FIVE-MAN SLOW PITCH SOFTBALL.** The pitcher is on the same team as the batter. The other players in the field may take any position they like. Play 2-out innings and 5-inning games.

**10-K BICYCLE RACE.** Lay out a course about 10 kilometers long. Have races for various classes-size of bikes, height and weight of Scouts competing.

**Variation:** Make it a bicycle orienteering course.

**2-K ORIENTEERING RACE.** Lay out an orienteering course about 2 kilometers long. The course could be run by individual Scouts or two-man teams.

**ACTION ARCHERY DUATHLON.** Set up an action archery course, with a running course between archery sites. Make sure that all safety rules are observed at archery sites. Scoring may include both the number of hits at archery sites and the time taken to complete the course.

### **Extreme Games**

Extreme games can be extremely physically challenging events that require months of training or they can be competitive patrol events that can be done during a troop activity. Boys will respond to the challenge of extreme games, and they can be easily planned and laid out without a lot of work. The event should involve the entire patrol, and should be divided into at least three events. The patrol with the total best time would be the winner.

Each event needs not be physically challenging. Some of the events should require reasoning and problem solving. Thus, every member of the patrol should be able to contribute to the achievement of the goal. Here are a few examples:

**A. Move an object, such as a sandbag or a bale of hay over a course with barriers, such as a hill or wall.**

The course need not be more than 100 yards long.

**B. Patrol Dash.**

Have them run a prescribed course depending on conditioning and terrain. It could be a trail run or a circular run.

**C. Canoe or kayak course.**

Select the best patrol members to represent the patrol in this event, which should be across a lake, or a pool.

**D. Bike relay.**

Select a course that some or all the patrol members would have to complete.

**E. Erect a tent.**

If you want to add some elements of difficulty, provide blindfolds, or do not allow anyone to talk.

**F. Kim's Game.**

Tape seven objects to a piece of cardboard. Allow each patrol to look at the objects for five seconds, then name all seven objects. Failure to name all the objects would mean to wait a full minute before the patrol could view the objects again.

**G. Other events could be created depending on the terrain and resources available.**

# ATHLETICS

## TROOP MEETING PLAN

Date \_\_\_\_\_ Week 1

ACTIVITY	DESCRIPTION	RUN BY	TIME
<b>Preopening</b> _____ minutes	Set up a 3-hole Frisbee golf course for Scouts. Also have a fitness chart to test each Scout on basic fitness skills; check for improvement during this month.		
<b>Opening Ceremony</b> _____ minutes	<ul style="list-style-type: none"> <li>• Form the troop into a semicircle.</li> <li>• Repeat the Scout Oath.</li> <li>• Present colors.</li> <li>• Repeat the Pledge of Allegiance.</li> </ul>		
<b>Skills Instruction</b> _____ minutes	<ul style="list-style-type: none"> <li>• New Scouts work on fitness skills. Record the best number of push-ups, pull-ups, standing long jump, and 500-yard run/walk (<i>Boy Scout Handbook</i>).</li> <li>• Experienced Scouts review a map of the area for the outing and plan the action archery duathlon and Frisbee golf course.</li> <li>• Older Scouts work on the Venture program or begin planning several intertroop games for field day.</li> </ul>		
<b>Patrol Meetings</b> _____ minutes	Discuss plans for the outing this month and make sure everyone knows what his assignments are and what to bring. Any Scouts who have not been camping yet will need extra help. All other patrols plan activities to work on advancement. Plan any meals that will be needed for the outing. If it will be an overnigher, plan now for equipment distribution and tent requirements.		
<b>Interpatrol Activity</b> _____ minutes	Play Everybody Up. (See the Games section of the <i>Troop Program Resources</i> .*)		
<b>Closing</b> _____ minutes Total 90 minutes of meeting	<ul style="list-style-type: none"> <li>• Have a Scout explain what sportsmanship means.</li> <li>• Scoutmaster's Minute.</li> <li>• Retire colors.</li> </ul>	SM	
<b>After the Meeting</b>	Patrol leaders' council reviews the next meeting and plans for the outing. Begin work on next month's program feature.		

\*Troop Program Resources for Scout Troops and Varsity Teams, Supply No. 33588

# ATHLETICS

## TROOP MEETING PLAN

Date \_\_\_\_\_ Week 2

ACTIVITY	DESCRIPTION	RUN BY	TIME
<b>Preopening</b> _____ minutes			
<b>Opening Ceremony</b> _____ minutes			
<b>Skills Instruction</b> _____ minutes	<ul style="list-style-type: none"> <li>• For the new Scouts, have a local college athlete or health club instructor demonstrate exercises and talk about a healthy diet and exercise plan. Also discuss the dangers of drug and alcohol abuse.</li> <li>• Experienced Scouts can plan a 20-K bike hike that includes some sort of Scouting skill at several stops.</li> <li>• Older Scouts can work on the Venture program.</li> </ul>		
<b>Patrol Meetings</b> _____ minutes	Review assignments for the outing. First-time campers continue to work on hiking and camping techniques. All other patrols continue to work on activities needed for advancement while on the outing. Practice interpatrol activities.		
<b>Interpatrol Activity</b> _____ minutes	Do Izzy-Dizzy Relay. (See the Games section of the <i>Troop Program Resources</i> .* )		
<b>Closing</b> _____ minutes Total 90 minutes of meeting	<ul style="list-style-type: none"> <li>• Scoutmaster's Minute.</li> <li>• Retire colors.</li> </ul>	SM	
<b>After the Meeting</b>	Patrol leaders' council reviews the next meeting and plans for the troop outing. Continue work on next month's program feature.		

\*Troop Program Resources for Scout Troops and Varsity Teams, Supply No. 33588

# ATHLETICS

## TROOP MEETING PLAN

Date \_\_\_\_\_ Week **3**

ACTIVITY	DESCRIPTION	RUN BY	TIME
<b>Preopening</b> _____ minutes			
<b>Opening Ceremony</b> _____ minutes			
<b>Skills Instruction</b> _____ minutes	<ul style="list-style-type: none"> <li>• New Scouts practice reading topographic maps and learn the symbols used on maps. Review the clothing and personal camping gear needed for camping (<i>Boy Scout Handbook</i>). Play Map Symbol Relay. (See the Games section of the <i>Troop Program Resources</i>.*)</li> <li>• Experienced Scouts can test themselves against the five groups on page 1 of the <i>Athletics</i> merit badge pamphlet, No. 33324.</li> <li>• Older Scouts work on the Venture program or work on topographic map orientation with younger Scouts.</li> </ul>		
<b>Patrol Meetings</b> _____ minutes	Discuss plans for this month's outing. Practice two of the events for the field day. All patrols plan activities to work on advancement.		
<b>Interpatrol Activity</b> _____ minutes	Play Dodgeball and Jump the Shot. (See the Games section of the <i>Troop Program Resources</i> .)		
<b>Closing</b> _____ minutes Total 90 minutes of meeting	<ul style="list-style-type: none"> <li>• Scoutmaster's Minute.</li> <li>• Retire colors.</li> </ul>	SM	
<b>After the Meeting</b>	Patrol leaders' council reviews the next meeting and plans for the outing. Continue work on next month's program feature.		

\*Troop Program Resources for Scout Troops and Varsity Teams, Supply No. 33588

# ATHLETICS

## TROOP MEETING PLAN

Date \_\_\_\_\_ Week 4

ACTIVITY	DESCRIPTION	RUN BY	TIME
<b>Preopening</b> _____ minutes			
<b>Opening Ceremony</b> _____ minutes			
<b>Skills Instruction</b> _____ minutes	<ul style="list-style-type: none"> <li>• New Scouts post their scores for the following activities to show improvement: push-ups, pull-ups, sit-ups, standing long jump, and 500-yard run/walk.</li> <li>• Experienced Scouts plan a menu of high-energy foods to have during the outing.</li> <li>• Older Scouts can work on the Venture program or help younger Scouts.</li> </ul>		
<b>Patrol Meetings</b> _____ minutes	Review all the events for the field day. If your patrol is small, one or two Scouts might have to compete twice in the same event. Practice two of the events for the outing.		
<b>Interpatrol Activity</b> _____ minutes	Play Crossing the Alligator Pit. (See the Games section of the <i>Troop Program Resources</i> .)		
<b>Closing</b> _____ minutes Total 90 minutes of meeting	<ul style="list-style-type: none"> <li>• Scoutmaster's Minute—reflection on the experiences of the month.</li> <li>• Retire colors.</li> </ul>	SM	
<b>After the Meeting</b>	Patrol leaders' council reviews the next meeting and checks last-minute details for the outing. Finalize work on next month's program feature.		

\*Troop Program Resources for Scout Troops and Varsity Teams, Supply No. 33588



# ATHLETICS

## TROOP OUTDOOR PROGRAM PLAN

**Date** \_\_\_\_\_

TIME	ACTIVITY	RUN BY
<b>Friday evening</b>	Load gear at meeting location, leave for campsite. Plan only a light meal en route.	SPL
	Arrive at the campsite. Off-load equipment. Set up patrol sites. Stow gear and set up camp.	PL/SPL
<b>Saturday</b> 6:30 A.M.	Cooks and assistants up. Prepare breakfast. (Cooks should be working on First and Second Class requirements.)	Cooks, assistants
7:00 A.M.	Everyone else up. Take care of personal hygiene, air tents, hang out sleeping bags.	
7:30 A.M.	Breakfast	
8:00 A.M.	Clean up.	Cooks
	Patrols set up the gear for morning activities, clean up patrol site.	
8:30–11:30 A.M.	Conduct athletics skill events.	SPL
11:30 A.M.	Sack lunch	
Noon	Continue events.	
4:30 P.M.	Start dinner preparation.	Cooks
5:30 P.M.	Meal	SPL
6:00 P.M.	Clean up.	Cooks
8:00 P.M.	Campfire	
9:00 P.M.	Cracker barrel	
10:00 P.M.	Lights out	
<b>Sunday</b> 6:30 A.M.	Cooks and assistants up. Prepare breakfast. (Cooks should be working on First and Second Class requirements.)	Cooks
7:00 A.M.	Everyone else up. Take care of personal hygiene, air tents, hang out sleeping bags.	
7:30 A.M.	Breakfast	
8:00 A.M.	Clean up.	Cooks
	Patrols set up the gear for morning activities, clean up patrol site.	
8:30 A.M.	Worship service	

TIME	ACTIVITY	RUN BY
9:00–11:00 A.M.	Hold play-off games for team events.	
11:00 A.M.	Break camp.	
<b>Special equipment needed</b>	Cameras, pens, troop camping equipment, athletic gear needed for events	

# BACKPACKING



Long before backpacking became a popular sport, the Boy Scouts of America was promoting this exhilarating activity. For many years, Philmont Scout Ranch in northern New Mexico has provided hundreds of miles of trails for thousands of Scouts across the country. In addition, BSA high-adventure bases and local councils throughout the country can provide Scouts with a stimulating backpacking experience.

Backpacking can be a single-day activity of several miles or a weeklong trip of 50 miles or longer. But no matter what length, participation requires hikers who are in top physical condition and prepared to meet the challenge. New Scouts can learn the basics of hiking and low-impact camping so that many thousands of people can enjoy the same trail for decades to come.

## SCOUTING OUTCOMES

This month's patrol and troop activities should give your Scouts

- Improved physical fitness

- A sense of communion with nature and God
- A greater appreciation for the outdoors and a determination to follow the Outdoor Code
- Enhanced self-confidence in their ability to be comfortable on the trail and in camp

## ADVANCEMENT OPPORTUNITIES

By month's end, all Scouts should have met the majority of their basic hiking and camping requirements through First Class. Depending on the outing activities, they may also complete all or part of the following rank requirements:

### *Tenderfoot*

- Outdoor—cooking, hiking, camping
- Citizenship—flag ceremonies
- Patrol/troop participation—patrol identification
- Personal development—Scout Oath and Law



*Second Class*

- Outdoor—cooking, camping, hiking, nature
- Citizenship—flag ceremonies
- Patrol/troop participation—patrol identification
- Personal development—Scout Oath and Law

*First Class*

- Outdoor—cooking, camping, nature, hiking
- Citizenship—flag ceremonies
- Patrol/troop participation—patrol identification
- Personal development—Scout Oath and Law

*Merit Badges.* Older Scouts can concentrate on the Backpacking and Hiking merit badges this month; they should be able to complete many of the requirements. Depending on activities during the month, they might also cover requirements in Camping, Cooking, Orienteering, Pioneering, Wilderness Survival, and other nature-related merit badges.

**PARENT/GUARDIAN PARTICIPATION**

The patrol leaders' council can involve parents in the program feature this month by

- Asking qualified parents to assist with instruction in camping and hiking skills
- Inviting parents on the backpacking outing
- Asking parents to provide transportation to the starting point for the hike, if necessary, and pick up at the end

**PATROL LEADERS' COUNCIL**

The patrol leaders' council should meet during the early part of the previous month to plan troop activities for this program feature. If you don't complete all items on the following agenda, continue planning at patrol leaders' council meetings after each troop meeting.

- Decide on the route and destination for the hike. If permission will be needed, assign someone to secure it.

- Decide whether it will be a day outing or a longer trek.
- Review skills needed for the hike.
- If the troop will be camping overnight, plan special activities. If special gear will be needed, assign someone to obtain it; seek the troop committee's help, if necessary.
- Plan details of troop meetings for the month. Assign patrol demonstrations, covering skills that will be needed for the hiking activities.

## **FEATURE EVENT**

### **Backpacking Outing**

Backpacking offers a multitude of program adventures for your troop. A hike or trek allows Scouts to interact with nature, test their physical abilities, presents photo opportunities for any camera bugs, and helps new Scouts meet their hiking and camping requirements through First Class.

You may want to organize the hike in stages, based on the skill levels and physical capabilities of the Scouts. One part could be relatively easy so that inexperienced Scouts can get a taste of backpacking. The second stage would give the more experienced young men a more challenging trail. Finally, the third stage would be a challenge for the older Scouts—almost a wilderness survival outing.

An unfamiliar route and destination would be best for the Scouts. Give them a topographic map and compass to find their way, or follow an established trail.

Conduct various activities along the route. Depending upon the needs of the group, you may want to consider one or more of the following highlights:

**NATURE NOOK.** Select a spot along the trail. Have each Scout select a 3-square-foot area and study wildlife within those boundaries. Note the plant life, animals, insects, etc.

**ENVIRONMENT PROJECT.** Check with local conservation authorities for an appropriate Good Turn. Here are some possibilities.

- Plant tree seedlings or shrubs to provide food and cover for wildlife.
- Build a check dam, deflector, or cover device to provide shelter for fish and to reduce streambank erosion.
- Build and set out nesting boxes for birds and small mammals like squirrels and raccoons.
- Plant hedges or windbreaks to provide winter cover for wildlife.
- Protect a streambank by planting grass or trees.
- Control erosion on hiking trails by constructing water bars or spreading a layer of an organic material such as sawdust, wood chips, pine needles, or leaves on the trail surface.

**HOW TALL, HOW FAR?** Locate a tall tree, mountain peak, cliff wall, etc., and have Scouts estimate its height and how far away it is.



# BACKPACKING

## TROOP MEETING PLAN

Date \_\_\_\_\_ Week 1

ACTIVITY	DESCRIPTION	RUN BY	TIME
<b>Preopening</b> _____ minutes	Locate the North Star, if it is dark enough, or practice telling directions without a compass. Set up a low-impact campsite for Scouts to see.		
<b>Opening Ceremony</b> _____ minutes	<ul style="list-style-type: none"> <li>• Form patrols into an open square.</li> <li>• Recite the Outdoor Code.</li> <li>• Present colors.</li> <li>• Repeat the Pledge of Allegiance.</li> </ul>		
<b>Skills Instruction</b> _____ minutes	<ul style="list-style-type: none"> <li>• New Scouts work on reading a compass and learn how to set a pace. Do Blindfold Compass Walk. (See the Games section of the <i>Troop Program Resources</i>. *)</li> <li>• Experienced Scouts work on choosing boots for backpacking and begin planning a 20-mile hike.</li> <li>• Older Scouts work on the Venture program. Review the principals of Leave No Trace and discuss ways they apply to the troop's next outing.</li> </ul>		
<b>Patrol Meetings</b> _____ minutes	Discuss plans for this month's outing and make sure everyone knows what his assignments are and what to bring for the outing. Any Scouts who have not been hiking yet will need some extra help. All other patrols can plan activities to work on advancement. Plan any meals that will be needed for the outing. If it will be an overnighter, plan now for equipment distribution and tent requirements.		
<b>Interpatrol Activity</b> _____ minutes	<ul style="list-style-type: none"> <li>• Play Hot Isotope Transport. (See the Games section of the <i>Troop Program Resources</i>. *)</li> <li>• Run a mile and record the times.</li> </ul>		
<b>Closing</b> _____ minutes Total 90 minutes of meeting	<ul style="list-style-type: none"> <li>• Assemble patrols, repeat the Scout Oath.</li> <li>• Scoutmaster's Minute.</li> <li>• Retire colors.</li> </ul>	SM	
<b>After the Meeting</b>	Patrol leaders' council reviews the next meeting and the backpacking outing. Begin work on next month's program feature.		

\*Troop Program Resources for Scout Troops and Varsity Teams, Supply No. 33588

# BACKPACKING

## TROOP MEETING PLAN

Date \_\_\_\_\_ Week 2

ACTIVITY	DESCRIPTION	RUN BY	TIME
<b>Preopening</b> _____ minutes			
<b>Opening Ceremony</b> _____ minutes			
<b>Skills Instruction</b> _____ minutes	<ul style="list-style-type: none"> <li>• New Scouts work on low-impact camping procedures, including site selection and cooking with Peak-type stoves.</li> <li>• Experienced Scouts work on packing procedures for the backpacking outing and select some campsites based on a topographic map of the camping area.</li> <li>• Older Scouts work on the Venture program or make plans to sleep under a shelter made from natural materials as part of the troop outing.</li> </ul>		
<b>Patrol Meetings</b> _____ minutes	Review assignments for the campout. First-time hikers in the new-Scout patrol continue working on troop procedures for hiking and camping. All other patrols continue to plan activities for advancement. Practice interpatrol activities.		
<b>Interpatrol Activity</b> _____ minutes	<ul style="list-style-type: none"> <li>• Run a mile and record the times.</li> <li>• Do Silver Dollar Hunt. (See the Games section of the <i>Troop Program Resources</i>.)</li> </ul>		
<b>Closing</b> _____ minutes  Total 90 minutes of meeting	<ul style="list-style-type: none"> <li>• Scoutmaster's Minute.</li> <li>• Retire colors.</li> </ul>	SM	
<b>After the Meeting</b>	Patrol leaders' council reviews the next meeting and plans for the troop outing. Continue work on next month's program feature.		

\*Troop Program Resources for Scout Troops and Varsity Teams, Supply No. 33588



# BACKPACKING

## TROOP MEETING PLAN

Date \_\_\_\_\_ Week 3

ACTIVITY	DESCRIPTION	RUN BY	TIME
<b>Preopening</b> _____ minutes			
<b>Opening Ceremony</b> _____ minutes			
<b>Skills Instruction</b> _____ minutes	<ul style="list-style-type: none"> <li>• New Scouts work on reading topographic maps and learn the symbols used on maps; also what to do if they get lost (<i>Boy Scout Handbook</i>). Play Map Symbol Relay. (See the Games section of the <i>Troop Program Resources</i>.*)</li> <li>• Experienced Scouts plan projects that could be done along the hike route.</li> <li>• Older Scouts work on the Venture program or help younger Scouts with topographic map orientation.</li> </ul>		
<b>Patrol Meetings</b> _____ minutes	Finalize the menu for the hike this week and make sure everyone knows what he will need to bring. Review clothing and equipment needs, and collect the necessary fees. Go over the hike route.		
<b>Interpatrol Activity</b> _____ minutes	<ul style="list-style-type: none"> <li>• Play Ball Over. (See the Games section of the <i>Troop Program Resources</i>.*)</li> <li>• Run a mile and record the times.</li> </ul>		
<b>Closing</b> _____ minutes  Total 90 minutes of meeting	<ul style="list-style-type: none"> <li>• Scoutmaster's Minute.</li> <li>• Retire colors.</li> </ul>	SM	
<b>After the Meeting</b>	Patrol leaders' council reviews the next meeting and plans for the hike. Continue work on next month's program feature.		

\*Troop Program Resources for Scout Troops and Varsity Teams, Supply No. 33588

# BACKPACKING

## TROOP MEETING PLAN

Date \_\_\_\_\_ Week 4

ACTIVITY	DESCRIPTION	RUN BY	TIME
<b>Preopening</b> _____ minutes			
<b>Opening Ceremony</b> _____ minutes			
<b>Skills Instruction</b> _____ minutes	<ul style="list-style-type: none"> <li>• New Scouts work on first aid for blisters, cuts, and sprains.</li> <li>• Experienced Scouts bring packs to the meeting and have a prehike inspection.</li> <li>• Older Scouts work on the Venture program or assist in teaching first-aid techniques.</li> </ul>		
<b>Patrol Meetings</b> _____ minutes	Review plans and assignments for the hike/campout. Make sure everyone knows the travel plans and equipment needs. Review the patrol duty roster. Practice any interpatrol activities that will take place during the hike.		
<b>Interpatrol Activity</b> _____ minutes	<ul style="list-style-type: none"> <li>• Do Star Hunt. (See the Games section of the <i>Troop Program Resources</i>.*)</li> <li>• Run a mile and record the times.</li> </ul>		
<b>Closing</b> _____ minutes Total 90 minutes of meeting	<ul style="list-style-type: none"> <li>• Scoutmaster's Minute—reflection on the experiences of the month.</li> <li>• Retire colors.</li> </ul>	SM	
<b>After the Meeting</b>	Patrol leaders' council reviews the next meeting and checks last-minute details for the outing. Finalize work on next month's program feature.		

\*Troop Program Resources for Scout Troops and Varsity Teams, Supply No. 33588

# BACKPACKING

## TROOP OUTDOOR PROGRAM PLAN

**Date** \_\_\_\_\_

TIME	ACTIVITY	RUN BY
<b>Friday evening</b>	Load gear at meeting location, leave for campsite. Plan only a light meal en route.	SPL
	Arrive at the campsite. Off-load equipment. Set up patrol sites. Stow gear and set up camp.	
<b>Saturday</b> 6:30 A.M.	Cooks and assistants up. Prepare breakfast. (Cooks should be working on First and Second Class requirements.)	Cooks, assistants
7:00 A.M.	Everyone else up. Take care of personal hygiene, air tents, hang out sleeping bags.	
7:30 A.M.	Breakfast	
8:00 A.M.	Clean up.	Cooks
	Patrols clean up patrol site.	
8:30–11:30 A.M.	Give patrol leaders a topographic map to make a 2- to 3-mile hike. The new-Scout patrol could take a simpler hike. Older Scouts could begin a 15- to 20-mile weekend survival hike.	SPL
11:30 A.M.	Sack lunch	
Noon	Continue hikes.	
4:30 P.M.	Start dinner preparation.	Cooks
5:30 P.M.	Dinner	SPL
6:00 P.M.	Clean up.	Cooks
8:00 P.M.	Campfire	
9:00 P.M.	Cracker barrel	
10:00 P.M.	Lights out	
<b>Sunday</b> 6:30 A.M.	Cooks and assistants up. Prepare breakfast. (Cooks should be working on First and Second Class requirements.)	Cooks
7:00 A.M.	Everyone else up. Take care of personal hygiene needs, air tents, hang out sleeping bags.	
7:30 A.M.	Breakfast	
8:00 A.M.	Clean up.	Cooks
	Patrols clean up patrol site.	
8:30 A.M.	Worship service	

TIME	ACTIVITY	RUN BY
9:00–11:00 A.M.	Patrol games—run a 1-K orienteering course.	
11:00 A.M.	Break camp.	
<b>Special equipment needs</b>	Topographic maps, clipboards, compasses, troop camping equipment	

## BOATING/CANOEING

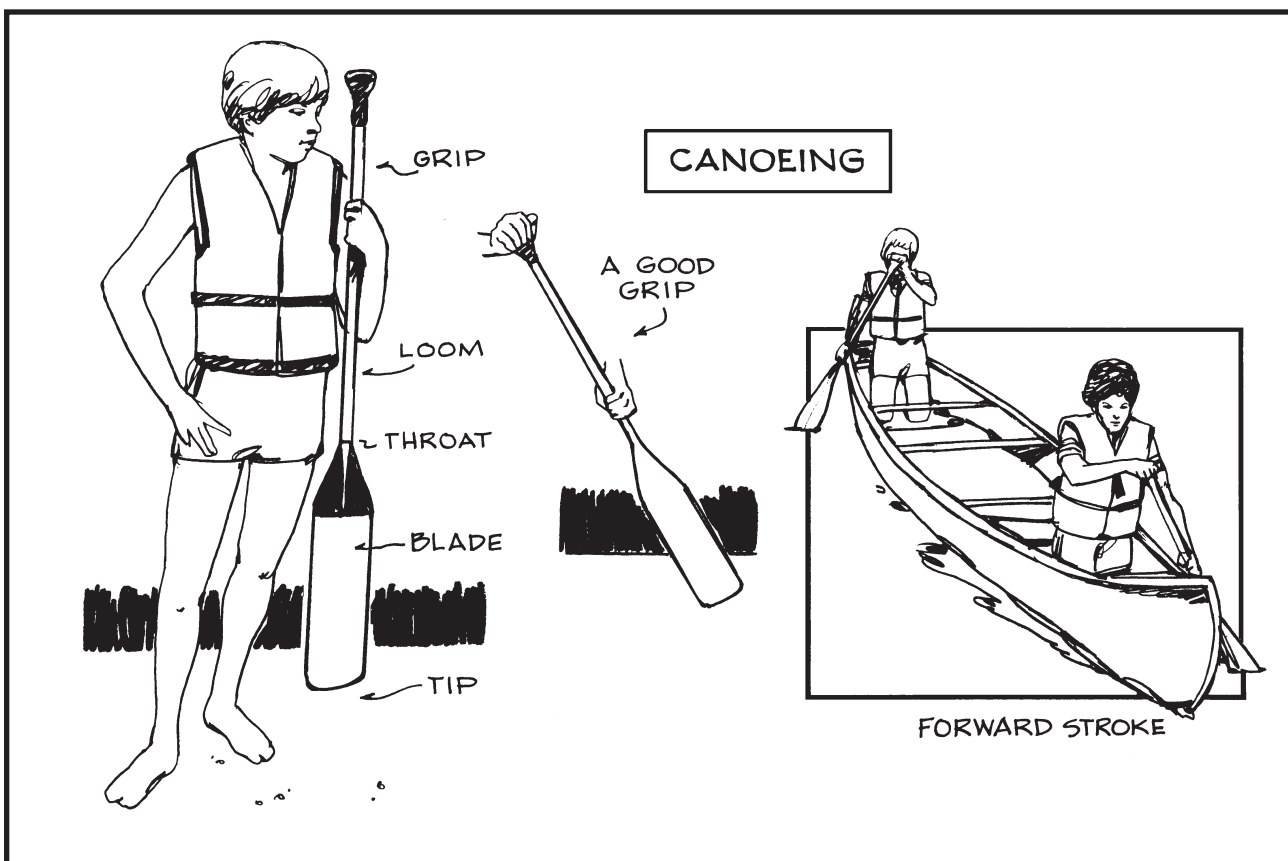

Activities on the water have been popular in Scouting since the founding of our organization. In this program feature, your Scouts will have an opportunity to pursue several forms of aquatic activities.

New Scouts can work on the swimming requirements for First and Second Class ranks. If possible, conduct all troop activities at a waterfront or swimming pool. If your troop does not have access to a waterfront or pool, ask your commissioner or district executive for help in finding one. Always enforce the Safe Swim Defense and Safety Afloat guidelines.

Prior planning is needed for any swimming or boating activity. It is required that at least one adult be certified in Safe Swim Defense and/or Safety Afloat, which also requires CPR from a community agency.

### SCOUTING OUTCOMES

This month's patrol and troop activities should give your Scouts

- A greater understanding of physical fitness
- Improved swimming skills
- Stronger boating and canoeing skills
- Enhanced self-confidence

### ADVANCEMENT OPPORTUNITIES

By month's end, all Scouts should have met the majority of their physical fitness requirements through First Class rank. Depending on the activities, they may also complete all or part of the following rank requirements:

#### *Tenderfoot*

- Patrol/troop participation—patrol identification
- Personal development—Scout Oath and Law
- Physical fitness—health, conditioning, swimming

#### *Second Class*

- Patrol/troop participation—patrol identification
- Personal development—Scout Oath and Law
- Physical fitness—health, conditioning, swimming

#### *First Class*

- Patrol/troop participation—patrol identification
- Personal development—Scout Oath and Law
- Physical fitness—health, conditioning, swimming

*Merit Badges.* Older Scouts can concentrate on the Canoeing and Rowing merit badges this month; they should be able to complete many of the requirements.

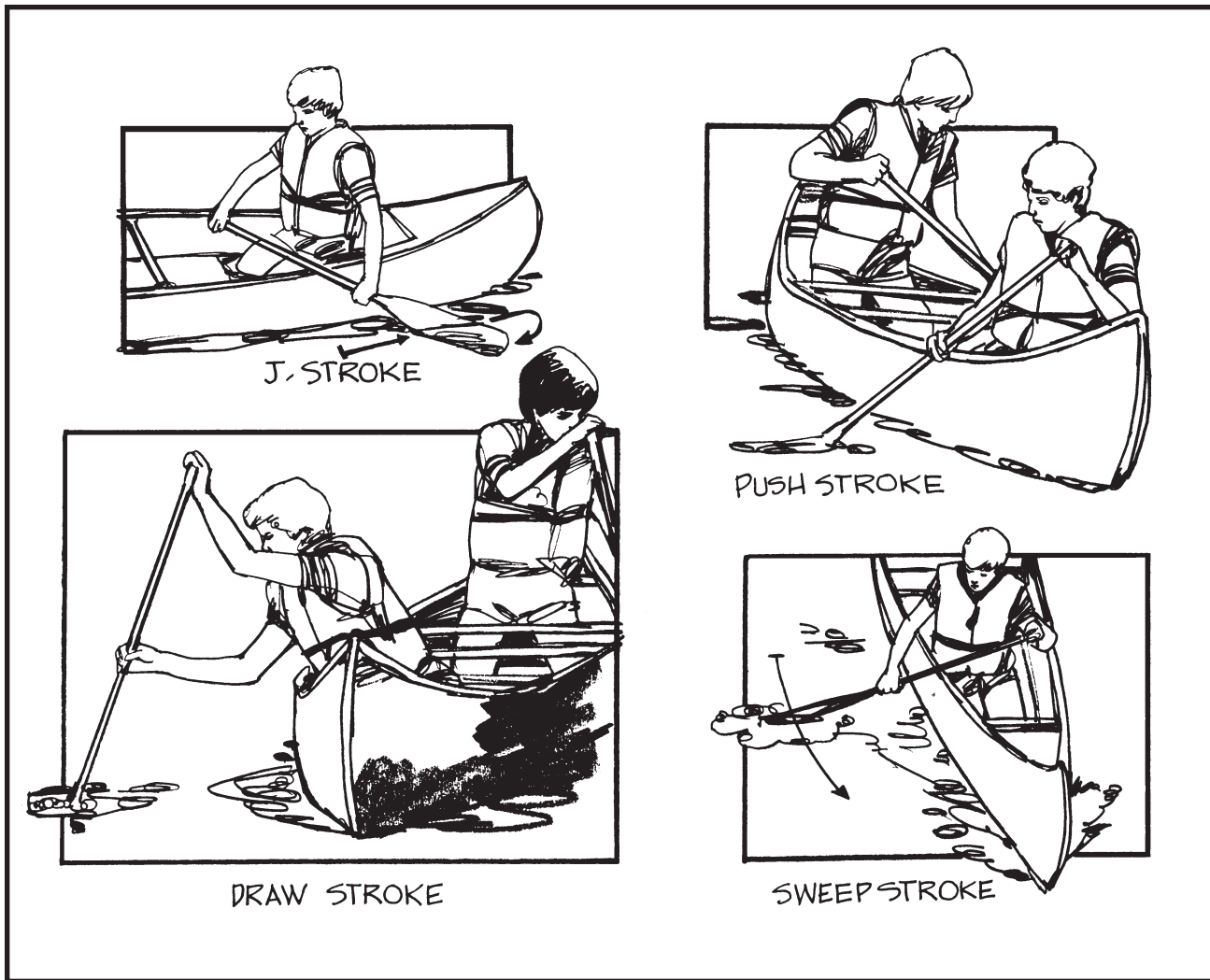

Depending on activities planned for the campout, they may also cover requirements in Athletics, Small-Boat Sailing, and Swimming.

**PARENT/GUARDIAN PARTICIPATION**

The patrol leaders' council can involve parents in the program feature this month by

- Asking those qualified to assist in aquatics instruction
- Inviting them on a canoe trip
- Asking them to provide transportation

**PATROL LEADERS' COUNCIL**

The patrol leaders' council should meet during the early part of the previous month to plan troop activities for this program feature. If you don't complete all items on the following agenda, continue planning at patrol leaders' council meetings after each troop meeting.

- Make plans for the canoe trip.
- Decide whether or not to make it an overnigher.
- Inventory the troop's camping equipment, if this has not been done recently.
- Plan details of troop meetings for the month.

**FEATURE EVENT**

**Canoeing/Rowing Outing**

This outing could be planned for a weekend or as a daylong activity. Several other activities could be combined with it as well. Older Scouts could take a canoe trip and join the rest of the troop on Saturday evening. Experienced Scouts could plan a canoe trip and the new Scouts could go along for the ride, provided they are classified as swimmers.

Boating activities could take place on a lake. If you have access to sailboats, a miniregatta could be run, with parents included as crew members. Or, you could

have a fishing tournament using boats to get you to your favorite fishing spot. If you have access to power boats that can pull water-skiers, you might conduct some water show activities on skis.

**PATROL RELAYS.** Run a swim relay in chest-deep water so that nonswimmers can walk their laps.

**UP AND UNDER.** (For Scouts and brothers and sisters.) Use a volleyball or beach ball for each team. All teams line up, relay fashion, in waist-deep water. The first player in each line is given the ball. On signal, he passes the ball back over his head to the next player in line, who passes it between his legs to the next player in line, who passes it between his legs to the next player, and so on to the end of the line. The last player runs to the head of the line and passes it as before. The first team back in its original order wins.

**GREASED WATERMELON.** Equipment: One medium-size watermelon, greased with shortening.

**Method:** Divide Scouts into two teams and station them in the water 25 feet apart. Float the watermelon halfway between the teams. On signal, each team tries to bring the watermelon back to its own line.

**Scoring:** The team that brings the watermelon back to its own line wins.

**BIG BLOW.** (For Scouts and brothers and sisters.) Play in water that is chest-deep for the shortest member. Each team lines up, relay fashion, and is given a table tennis ball or toy boat. On signal, the first player on each team swims or walks to a turning line and back while blowing the ball or boat ahead of him. The following players repeat the action until all have run.





# BOATING/CANOEING

## TROOP MEETING PLAN

Date \_\_\_\_\_ Week 1

ACTIVITY	DESCRIPTION	RUN BY	TIME
<b>Preopening</b> _____ minutes	Meet at the waterfront or pool, if possible. Use Safe Swim Defense ( <i>Boy Scout Handbook</i> ). If the meeting is held at your meeting place, make buddy tags ( <i>Swimming</i> merit badge pamphlet).		
<b>Opening Ceremony</b> _____ minutes			
<b>Skills Instruction</b> _____ minutes	Test the swimming ability of all Scouts and classify each as nonswimmer, beginner, or swimmer. Pair up buddies. Have instruction for nonswimmers. <ul style="list-style-type: none"> <li>• New Scouts begin working on swimming strokes needed for Tenderfoot through First Class.</li> <li>• Experienced Scouts (if they are classified as swimmers) begin planning a canoe trip that could be held on a week-end. (You may want to include new Scouts on the trip.)</li> <li>• Older Scouts work on the Venture program, or, if you will have access to sailboats on the troop outing, plan a regatta.</li> </ul>		
<b>Patrol Meetings</b> _____ minutes	If you are planning a canoe trip, review Safety Afloat rules ( <i>Scoutmaster Handbook</i> ). Note that only swimmers may be in canoes. Plan to follow these rules for all boating activities.		
<b>Interpatrol Activity</b> _____ minutes	Play Spoon Race. (See the Games section of the <i>Troop Program Resources</i> .* )		
<b>Closing</b> _____ minutes  Total 90 minutes of meeting	<ul style="list-style-type: none"> <li>• Scoutmaster's Minute.</li> <li>• Retire colors.</li> </ul>	SM	
<b>After the Meeting</b>	Patrol leaders' council reviews the next meeting and plans for the outing. Begin work on next month's program feature.		

\*Troop Program Resources for Scout Troops and Varsity Teams, Supply No. 33588

# BOATING/CANOEING

## TROOP MEETING PLAN

Date \_\_\_\_\_ Week 2

ACTIVITY	DESCRIPTION	RUN BY	TIME
<b>Preopening</b> _____ minutes			
<b>Opening Ceremony</b> _____ minutes			
<b>Skills Instruction</b> _____ minutes	<ul style="list-style-type: none"> <li>• New Scouts continue working on swimming strokes that are needed for First and Second Class.</li> <li>• Experienced Scouts practice paddling and righting a swamped canoe.</li> <li>• Older Scouts work on the Venture program, help with the instruction of younger Scouts, or continue planning the regatta.</li> </ul>		
<b>Patrol Meetings</b> _____ minutes	Continue work on aquatics skills.		
<b>Interpatrol Activity</b> _____ minutes	Continue aquatics activities.		
<b>Closing</b> _____ minutes Total 90 minutes of meeting	<ul style="list-style-type: none"> <li>• Scoutmaster's Minute.</li> <li>• Retire colors.</li> </ul>	SM	
<b>After the Meeting</b>	Patrol leaders' council reviews the next meeting and plans for the outing. Continue work on next month's program feature.		

# BOATING/CANOEING

## TROOP MEETING PLAN

Date \_\_\_\_\_ Week 3

ACTIVITY	DESCRIPTION	RUN BY	TIME
<b>Preopening</b> _____ minutes			
<b>Opening Ceremony</b> _____ minutes			
<b>Skills Instruction</b> _____ minutes	<ul style="list-style-type: none"> <li>• New Scouts continue working on swimming strokes needed for First and Second Class.</li> <li>• Experienced Scouts practice packing and portaging a canoe.</li> <li>• Older Scouts work on the Venture program, help with the instruction of younger Scouts, or have sailing practice.</li> </ul>		
<b>Patrol Meetings</b> _____ minutes	Continue work on swimming skills.		
<b>Interpatrol Activity</b> _____ minutes	Continue aquatics activities.		
<b>Closing</b> _____ minutes Total 90 minutes of meeting	<ul style="list-style-type: none"> <li>• Scoutmaster's Minute.</li> <li>• Retire colors.</li> </ul>	SM	
<b>After the Meeting</b>	Patrol leaders' council reviews the next meeting and plans for the outing. Continue work on next month's program feature.		

# BOATING/CANOEING

## TROOP MEETING PLAN

Date \_\_\_\_\_ Week 4

ACTIVITY	DESCRIPTION	RUN BY	TIME
<b>Preopening</b> _____ minutes			
<b>Opening Ceremony</b> _____ minutes			
<b>Skills Instruction</b> _____ minutes	<ul style="list-style-type: none"> <li>• New Scouts are tested on swimming strokes needed for First and Second Class.</li> <li>• Experienced Scouts finalize plans for canoe trip and assign all duties.</li> <li>• Older Scouts work on the Venture program, or finalize plans for the regatta and assist with instruction of younger Scouts.</li> </ul>		
<b>Patrol Meetings</b> _____ minutes	Continue work on swimming skills.		
<b>Interpatrol Activity</b> _____ minutes			
<b>Closing</b> _____ minutes Total 90 minutes of meeting	<ul style="list-style-type: none"> <li>• Scoutmaster's Minute—reflection on the experiences of the month.</li> <li>• Retire colors.</li> </ul>	SM	
<b>After the Meeting</b>	Patrol leaders' council reviews the next meeting and checks last-minute details for the outing. Finalize work on next month's program feature.		

## BOATING/CANOEING

### TROOP OUTDOOR PROGRAM PLAN

**Date** \_\_\_\_\_

TIME	ACTIVITY	RUN BY
<b>Friday evening</b>	Load gear at meeting location, leave for campsite. Plan only a light meal en route.	SPL
	Arrive at the campsite; off-load equipment. Set up patrol sites. Stow gear and set up camp.	SPL/PL
	Unload canoes for Scouts going on trip.	
<b>Saturday</b> 6:30 A.M.	Cooks and assistants up. Prepare breakfast. (Cooks should be working on First and Second Class requirements.)	Cooks, assistants
7:00 A.M.	Everyone else up. Take care of personal hygiene, air tents, hang out sleeping bags.	
7:30 A.M.	Breakfast	
8:00 A.M.	Clean up.	Cooks
	Patrols set up the gear for morning activities, clean up patrol site.	
	Launch for canoe trip.	
8:30–11:30 A.M.	Begin regatta, if you have planned one, or a fishing tournament. If the younger Scouts are not doing aquatic activities, have them take a nature hike.	SPL
11:30 A.M.	Sack lunch	
Noon	Continue activities.	
4:30 P.M.	Start dinner preparation.	Cooks
5:30 P.M.	Dinner	SPL
6:00 P.M.	Clean up.	Cooks
8:00 P.M.	Campfire. Share experiences on canoe trip.	
9:00 P.M.	Cracker barrel	
10:00 P.M.	Lights out	
<b>Sunday</b> 6:30 A.M.	Cooks and assistants up. Prepare breakfast. (Cooks should be working on First and Second Class requirements.)	Cooks
7:00 A.M.	Everyone else up. Take care of personal hygiene, air tents, hang out sleeping bags.	
7:30 A.M.	Breakfast	
8:00 A.M.	Clean up.	Cooks
	Patrols clean up patrol site.	

TIME	ACTIVITY	RUN BY
8:30 A.M.	Worship service	
9:00–11:00 A.M.	Play four games from the Games section of the <i>Troop Program Resources</i> ,* or have a runoff in the regatta or fishing tournament.	
11:00 A.M.	Break camp.	
<b>Special equipment needed</b>	Topographic maps, clipboards, compasses, troop camping equipment, canoes, sailboats, rowboats, fishing gear	

\**Troop Program Resources for Scout Troops and Varsity Teams*, Supply No. 33588

## BUSINESS

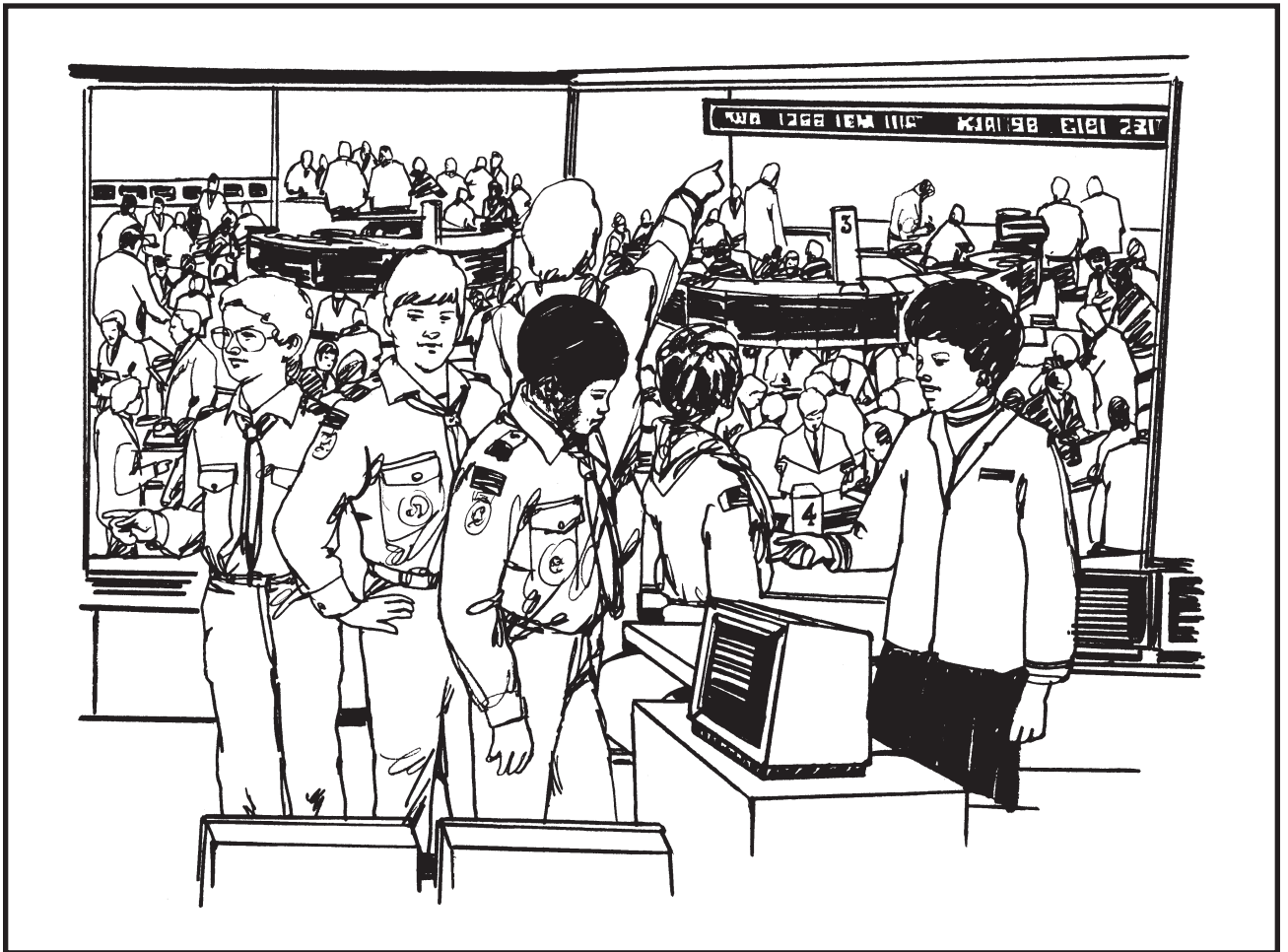

In a few years, the Scouts in your troop will have the right to vote, own property, and sign contracts. This month we will introduce them to the responsibilities they will have as adults in dealing with their business affairs. They will also learn something about how businesses operate in our society.

For one troop meeting, plan a visit to a local business or industry to learn how the free enterprise system works. Make arrangements beforehand to have a guided tour or a meeting with a company official to discuss business. The patrol leaders' council might also want to invite a business person to a troop meeting.

The big event will be a campout to practice Scoutcraft skills.

### SCOUTING OUTCOMES

This month's patrol and troop activities should give your Scouts

- A better understanding of the free enterprise system
- Enhanced outdoor skills

- A greater understanding of the importance of conservation
- Enhanced self-confidence

### ADVANCEMENT OPPORTUNITIES

By month's end, all Scouts should have met the majority of their basic citizenship requirements through First Class. Depending on the campout activities, they may also complete all or part of the following rank requirements:

#### *Tenderfoot*

- Outdoor—hiking, camping
- Citizenship—flag ceremonies
- Patrol/troop participation—patrol identification
- Personal development—Scout Oath and Law

#### *Second Class*

- Outdoor—camping, cooking, hiking
- Citizenship—flag ceremonies

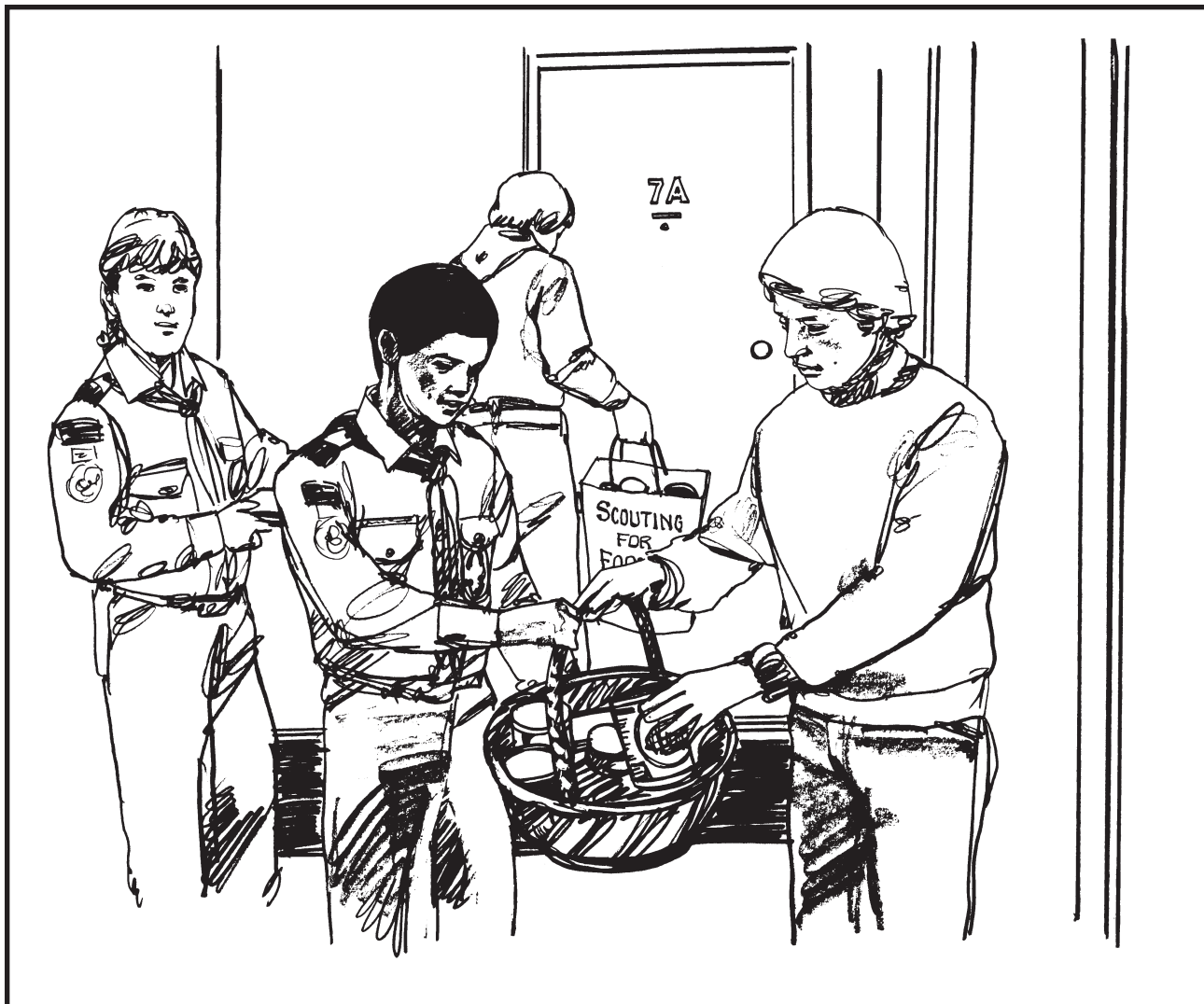

- Patrol/troop participation—patrol identification
- Personal development—Scout Oath and Law

*First Class*

- Outdoor—camping, hiking, cooking, nature
- Citizenship—flag ceremonies
- Patrol/troop participation—patrol identification
- Personal development—Scout Oath and Law

*Merit Badges.* Experienced Scouts may concentrate on the American Business, American Labor, Citizenship in the Community, and Citizenship in the Nation merit badges this month. They should be able to complete many of the requirements. Depending on activities during the month, they may also complete requirements in Camping, Cooking, Hiking, and other outdoor-related merit badges.

**PARENT/GUARDIAN PARTICIPATION**

The patrol leaders' council may involve parents in the program feature this month by

- Asking those qualified to assist with instruction for citizenship and business skills
- Inviting families on the outing
- Asking them to provide transportation for the visit to a business and the outing

**PATROL LEADERS' COUNCIL**

The patrol leaders' council should meet during the early part of the previous month to plan troop activities for this program feature. If you don't complete all items on the following agenda, continue planning at patrol leaders' council meetings after each troop meeting.

- Decide what business the troop will visit this month and make arrangements for the visit.



- Make arrangements to invite a community or business leader to the second troop meeting to discuss his or her work and moderate a discussion of the rights and duties of a citizen.
- Plan the special activities for the outing.
- Inventory the troop's camping equipment, if this hasn't been done recently.
- Plan details of troop meetings for the month. Assign patrol demonstrations, covering skills that will be needed for completion of advancement through First Class rank.

## **FEATURE EVENT**

### **Business Outing**

Discovering the world of business and how business and government in our country work together can be an exciting adventure. You have an opportunity to see how business works right in your own community. Take the opportunity to get to know how your community and local businesses work. Get a local business person to meet with the troop and discuss how his or her business operates.

## **BUSINESS PROJECTS**

Here are some ideas for patrols or individual Scouts.

**STOCK MARKET.** Invite a stockbroker to visit the troop, and give a brief explanation of how the stock market works. Have each patrol, or better still, each Scout, select a particular stock or mutual fund and track it for a period of time. Compare the results, and see which Scouts do the best—and the worst.

**CREDIT CARDS.** Explain how a credit card works. Explain how important credit is to an individual, and why it is so vital a person should pay credit card charges in a timely manner. How a credit card charges interest, and why it is a good idea to keep credit card charges under control.

**LOANS.** Find out how to get a loan from a bank. What would the interest rate be? How much interest would you have to pay if the loan was for six months?

**BONDS.** Look into the cost of purchasing a municipal bond. How much interest would you earn by the time the bond matures?

**“RUN” A COMPANY.** Set up an imaginary company to manufacture widgets. Develop a product plan, a marketing strategy, and a sales plan.

**PRODUCT SALES.** Set up a sales campaign and a marketing plan for some product—baseball gloves, hiking boots, tents, etc.



# BUSINESS

## TROOP MEETING PLAN

Date \_\_\_\_\_ Week 1

ACTIVITY	DESCRIPTION	RUN BY	TIME
<b>Preopening</b> _____ minutes	A pair of experienced Scouts show how to fold and care for the U.S. flag ( <i>Boy Scout Handbook</i> ).		
<b>Opening Ceremony</b> _____ minutes	<ul style="list-style-type: none"> <li>• Form troop into parallel patrols.</li> <li>• Present colors.</li> <li>• Sing the national anthem.</li> <li>• Hold a uniform inspection.</li> </ul>		
<b>Skills Instruction</b> _____ minutes	<ul style="list-style-type: none"> <li>• New Scouts practice U.S. flag courtesies, including raising, lowering, and folding the flag. Plan and rehearse an opening flag ceremony to use at next week's meeting. Play How High? (See the Games section of the <i>Troop Program Resources</i>.*)</li> <li>• Experienced Scouts visit a business and find out how it operates. They learn what it takes to operate a business.</li> <li>• Older Scouts work on the Venture program or begin planning a 100-mile bike hike.</li> </ul>		
<b>Patrol Meetings</b> _____ minutes	Discuss plans for a patrol outing this month. This outing could be a 5- or 10-mile hike so that newer Scouts can work on their hiking skills. Or, plan a patrol Good Turn.		
<b>Interpatrol Activity</b> _____ minutes	Play Thurman Throw. (See the Games section of the <i>Troop Program Resources</i> .*)		
<b>Closing</b> _____ minutes  Total 90 minutes of meeting	<ul style="list-style-type: none"> <li>• Scoutmaster's Minute.</li> <li>• Retire colors.</li> </ul>	SM	
<b>After the Meeting</b>	Patrol leaders' council reviews the next meeting and plans for the outing. Begin work on next month's program feature.		

\*Troop Program Resources for Scout Troops and Varsity Teams, Supply No. 33588

# BUSINESS

## TROOP MEETING PLAN

Date \_\_\_\_\_ Week 2

ACTIVITY	DESCRIPTION	RUN BY	TIME
<b>Preopening</b> _____ minutes			
<b>Opening Ceremony</b> _____ minutes			
<b>Skills Instruction</b> _____ minutes	<ul style="list-style-type: none"> <li>• New Scouts meet with an elected public official, either at the troop meeting place or the official's office. Learn what he or she does. Discuss rights and duties of citizens.</li> <li>• Experienced Scouts plan a community Good Turn. This might be in support of something your community is currently doing. Or it could be a get-out-the-vote campaign for an upcoming election, or a park beautification project. (The Good Turn need not be held this month.) Play Steal-the-Bacon. (See the Games section of the <i>Troop Program Resources</i>. *)</li> <li>• Older Scouts work on the Venture program or continue preparing for a 100-mile bike hike.</li> </ul>		
<b>Patrol Meetings</b> _____ minutes	Review needs of Scouts in the patrol to participate in flag ceremonies and service projects. Suggest activities that these Scouts can participate in to fulfill rank requirements.		
<b>Interpatrol Activity</b> _____ minutes	Play Kim's Game. (See the Games section of the <i>Troop Program Resources</i> . *)		
<b>Closing</b> _____ minutes  Total 90 minutes of meeting	<ul style="list-style-type: none"> <li>• Scoutmaster's Minute.</li> <li>• Retire colors.</li> </ul>	SM	
<b>After the Meeting</b>	Patrol leaders' council reviews the next meeting and plans for the outing. Continue work on next month's program feature.		

\*Troop Program Resources for Scout Troops and Varsity Teams, Supply No. 33588

# BUSINESS

## TROOP MEETING PLAN

Date \_\_\_\_\_ Week 3

ACTIVITY	DESCRIPTION	RUN BY	TIME
<b>Preopening</b> _____ minutes			
<b>Opening Ceremony</b> _____ minutes			
<b>Skills Instruction</b> _____ minutes	<ul style="list-style-type: none"> <li>• New Scouts work on basic hiking skills.</li> <li>• Experienced Scouts work on map and compass skills.</li> <li>• Older Scouts work on the Venture program, help with instruction in map and compass, or finish plans for a 100-mile bike hike.</li> </ul>		
<b>Patrol Meetings</b> _____ minutes	Review plans and assignments for the campout. Make sure everyone knows travel plans and equipment needs. Practice interpatrol activities.		
<b>Interpatrol Activity</b> _____ minutes	Play Sit-Down Dodgeball (regular Dodgeball played in sitting position). (See the Games section of the <i>Troop Program Resources</i> .)		
<b>Closing</b> _____ minutes  Total 90 minutes of meeting	<ul style="list-style-type: none"> <li>• Scoutmaster's Minute.</li> <li>• Retire colors.</li> </ul>	SM	
<b>After the Meeting</b>	Patrol leaders' council reviews the next meeting and plans for the next outing. Continue work on next month's program feature.		

\*Troop Program Resources for Scout Troops and Varsity Teams, Supply No. 33588

# BUSINESS

## TROOP MEETING PLAN

Date \_\_\_\_\_ Week 4

ACTIVITY	DESCRIPTION	RUN BY	TIME
<b>Preopening</b> _____ minutes			
<b>Opening Ceremony</b> _____ minutes			
<b>Skills Instruction</b> _____ minutes	Visit a local business or industry and find out how its operations fit into the economy of your community, the country, and the world. See how the free enterprise system works in your area. Or, visit a local government office or facility.		
<b>Patrol Meetings</b> _____ minutes			
<b>Interpatrol Activity</b> _____ minutes			
<b>Closing</b> _____ minutes Total 90 minutes of meeting	<ul style="list-style-type: none"> <li>• Scoutmaster's Minute—reflection on the experiences of the month.</li> <li>• Retire colors.</li> </ul>	SM	
<b>After the Meeting</b>	Patrol leaders' council reviews the next meeting and checks last-minute details for this month's outing. Finalize work on next month's program feature.		

# BUSINESS

## TROOP OUTDOOR PROGRAM PLAN

Date \_\_\_\_\_

TIME	ACTIVITY	RUN BY
<b>Friday evening</b>	Load gear at meeting location, leave for campsite. Plan only a light meal en route.	SPL
	Arrive at campsite; off-load equipment. Set up patrol sites. Stow gear and set up camp.	SPL/PL
<b>Saturday</b> 6:30 A.M.	Cooks and assistants up. Prepare breakfast. (Cooks should be working on First and Second Class requirements.)	Cooks, assistants
7:00 A.M.	Everyone else up. Take care of personal hygiene, air tents, hang out sleeping bags.	
7:30 A.M.	Breakfast	
8:00 A.M.	Clean up.	Cooks
	Patrols put up the gear for morning activities, clean up patrol site.	
8:30–11:30 A.M.	Give patrol leaders a topographic map to lead a three- to five-mile hike. Scouts working on First Class could take part in an orienteering race. Younger Scouts could take a nature hike.	SPL
11:30 A.M.	Sack lunch	
Noon	Continue activities.	
4:30 P.M.	Start dinner preparation.	Cooks
5:30 P.M.	Dinner	SPL
6:00 P.M.	Clean up.	Cooks
8:00 P.M.	Campfire	
9:00 P.M.	Cracker barrel	
10:00 P.M.	Lights out	
<b>Sunday</b> 6:30 A.M.	Cooks and assistants up. Prepare breakfast. (Cooks should be working on First and Second Class requirements.)	Cooks
7:00 A.M.	Everyone else up. Take care of personal hygiene, air tents, hang out sleeping bags.	
7:30 A.M.	Breakfast	
8:00 A.M.	Clean up.	Cooks
	Patrols put up gear for morning activities, clean up patrol site.	

TIME	ACTIVITY	RUN BY
8:30 A.M.	Worship service	
9:00–11:00 A.M.	Patrol games—use four games from Games section of the <i>Troop Program Resources</i> . *	
11:00 A.M.	Break camp.	
<b>Special equipment needed</b>	Topographic maps, clipboards, compasses, troop camping equipment	

\**Troop Program Resources for Scout Troops and Varsity Teams*, Supply No. 33588



# CAMPING

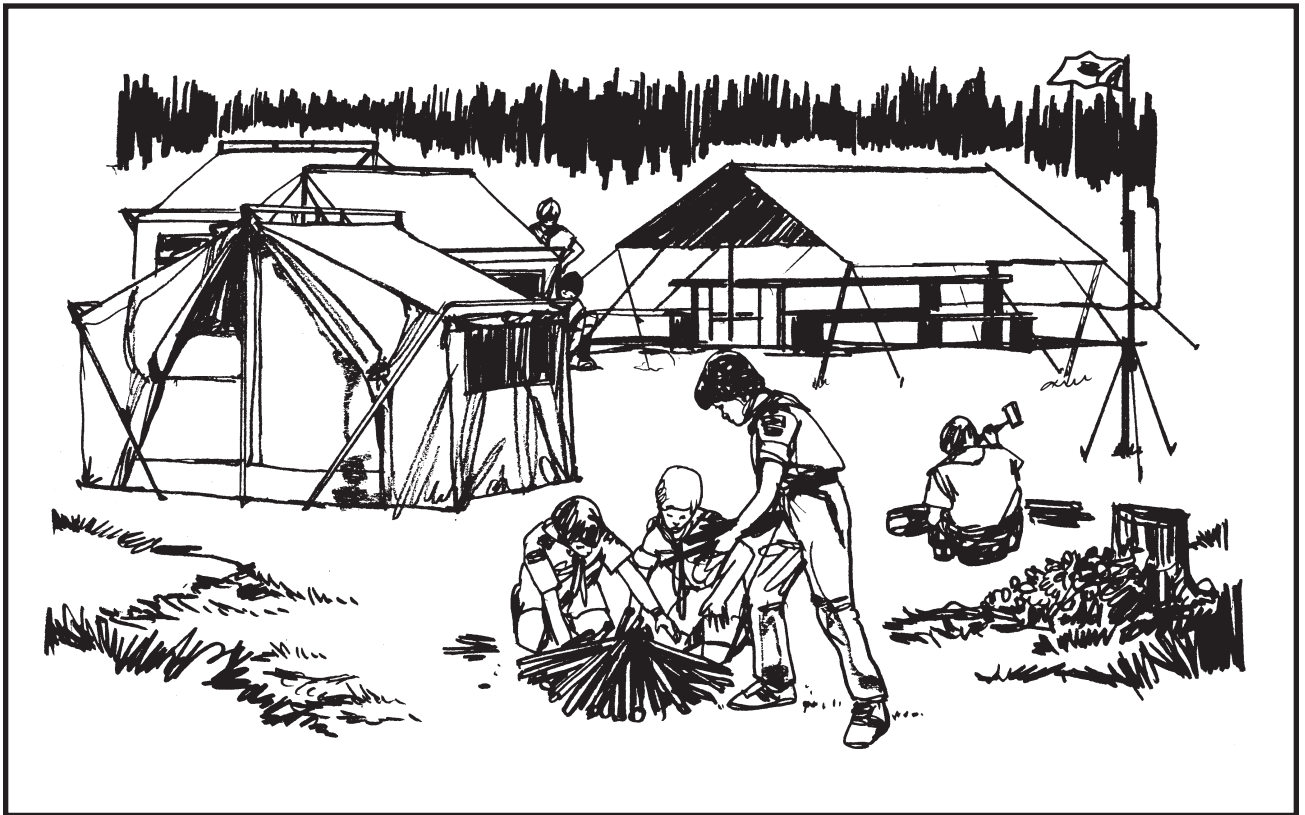

Nowhere is the romance of the BSA more evident than in camp. Whether it's an overnight campout or a week at summer camp, an outdoor setting promises fun and adventure—two of Scouting's great attractions.

A troop that camps out almost every month of the year will have a strong appeal to Scouts. On the other hand, a troop that rarely gets outdoors might have trouble holding the interest of boys.

This month's program focuses on camping skills. Young Scouts learn the basics of living comfortably and safely in the outdoors. Older Scouts can hone their knowledge of essential skills and tackle more advanced campcraft. Everyone in the troop will master Leave No Trace camping methods so that they can live in the outdoors in ways that are kind to the environment.

The big event of the month will be a campout that encourages Scouts to improve their camping skills. The campout might have another emphasis, too—perhaps nature study, astronomy, conservation, fishing, or wilderness survival.

Consider hiking at least a few miles to and from the campsite. That will increase the sense of remoteness for Scouts and allow them to practice backpacking as well as camping. The patrol leaders' council should plan the campout to emphasize Leave No Trace camping methods outlined in the *Boy Scout Handbook*. The

patrol leaders' council can also plan activities that will be enjoyable and enhance the troop's Scoutcraft skills. Add an evening program full of fun and inspiration to cap off this great outdoor adventure.

## SCOUTING OUTCOMES

This month's patrol and troop activities should give your Scouts

- The knowledge and skill to be comfortable in camp
- The ability to use Leave No Trace camping methods and the Outdoor Code to protect the environment
- A sense of communion with nature and God
- Growth in self-confidence
- The ability to work cooperatively with other members of the patrol and troop in an outdoor setting

## ADVANCEMENT OPPORTUNITIES

By the end of the month all Scouts should have met the majority of their basic camping requirements through First Class rank. Depending on the campout activities, they might also complete all or part of the following rank requirements:



#### *Tenderfoot*

- Outdoor—cooking, camping
- Citizenship—flag ceremonies, Good Turn
- Patrol/troop participation—patrol identification
- Personal development—Scout Oath and Law

#### *Second Class*

- Outdoor—cooking, camping, hiking
- Citizenship—flag ceremonies, Good Turn
- Patrol/troop participation—leadership
- Personal development—Scout Oath and Law

#### *First Class*

- Outdoor—cooking, camping, hiking
- Citizenship—flag ceremonies, Good Turn
- Patrol/troop participation—leadership
- Personal development—Scout Oath and Law

*Merit Badges.* Older Scouts can concentrate on the Camping merit badge this month, completing most of the requirements. Depending on activities planned for the campout, they might also fulfill various

requirements for Cooking, Hiking, Orienteering, Pioneering, Wilderness Survival, and other outdoor- and nature-related merit badges.

#### **PARENT/GUARDIAN PARTICIPATION**

The patrol leaders' council can involve parents and guardians in the camping program feature by

- Asking qualified parents and guardians to assist with instruction for camping skills and Leave No Trace techniques
- Inviting parents and guardians to participate in the troop campout
- Asking them to provide transportation to and from the campsite or the starting point of the hike to camp

#### **PATROL LEADERS' COUNCIL**

The patrol leaders' council should have met in the middle of the previous month to plan troop activities for this program feature. If they didn't complete all of the items on the following agenda, they can continue planning at brief patrol leaders' council meetings after each troop meeting.



- Decide on a campsite. If permission will be needed from private landowners or public land managers, they should be secured by the Scoutmaster, a member of the troop committee, or other responsible adult.
- Plan any special activities for the campout.
- If special gear or tools will be needed, assign someone to obtain them. Seek help from the troop quartermaster and, if necessary, the troop committee.
- Inventory the troop's camping equipment if this has not been done recently.
- Plan details of troop meetings for the month. Assign patrol demonstrations for the month, covering skills that will be needed for campout activities and Leave No Trace camping methods.

## **BIG EVENT**

### **The Troop Campout**

The primary purpose of this campout will be to make all Scouts feel at home spending the night outdoors. The patrol leaders' council should take special care to see that younger Scouts will have a good time, be

comfortable in camp, and be enthusiastic about going camping again.

The event can take place at one of the troop's usual campsites, at the local council's Scout camp, or at a public park or forest. Plan for the patrol leaders' council or the troop's leaders to inspect each patrol's site to ensure that all Scouts are following Leave No Trace camping methods. Use the campout as an opportunity to recognize and praise good technique and to help all Scouts become responsible campers.

### **CAMPOUT ACTIVITIES**

The activity schedule of a campout will depend on weather, what the site has to offer, whether or not the Scouts are hiking to the campground, and the interests and needs of the troop members. Orienteering, nature study, fishing, pioneering—there are plenty of possibilities. A troop with many younger Scouts might plan instruction and practice in outdoor skills including campcraft, cooking, estimating heights and distances, safely handling woods tools, using maps and compasses, and so on.

To add spice to the practice, the patrol leaders' council could plan interpatrol competition in these skills. Try some of these contests from the "Games" section of *Troop Program Resources for Scout Troops and Varsity Teams*:

- Blindfold Compass Walk
- Knot-Tying Relay
- Nature Scavenger Hunt
- Bow-Saw Relay
- Wet-Weather Fire Building
- String-Burning Race
- Remote Clove-Hitch Tying
- Flagpole Raising

### **Wide Games for Camp**

If your campsite has a large wooded area, the patrol leaders' council might want to plan a wide game for the troop. Most wide games require up to a half-mile-square territory, and they last about 30 minutes. Several wide games, including Capture the Flag, Deliver the Message, and Infiltration are explained in the Games section of *Troop Program Resources for Scout Troops and Varsity Teams*.

### **The Campout's Evening Program**

A highlight of campouts is an evening program for sharing stories, songs, skits, and ideas. In areas where open fires are appropriate, a campfire can serve as the centerpiece of the program.

A troop's evening program during a campout should have elements of fun, inspiration, and good fellowship. It should leave each Scout with pleasant memories. The program need not be an elaborate production, but it does require planning. Evening programs usually last about an hour; it's better to end a program while Scouts are enjoying it rather than letting it drag on until they become restless.

The patrol leaders' council should take the lead in planning an evening program and assigning its various parts to the patrols. Scouts who have been to campouts and summer camp might have ideas for skits, stunts, and songs. The patrol leaders' council might also find it helpful to use the Campfire Program Planner and the *Patrol Leader Handbook*, which contain information on planning effective evening programs.

As with all BSA events, an evening campout program must be in good taste. Adult leaders should reinforce the fact that there is no place in Scouting for poor manners; racial, ethnic, or gender slurs; or vulgarity.

# CAMPING

## TROOP MEETING PLAN

Date \_\_\_\_\_ Week 1

ACTIVITY	DESCRIPTION	RUN BY	TIME
<b>Preopening</b> _____ minutes	Meet outdoors. Have new Scouts practice whipping rope. Other Scouts can work on splicing rope and lashings with Scout staves ( <i>Boy Scout Handbook</i> ).		
<b>Opening Ceremony</b> _____ minutes	<ul style="list-style-type: none"> <li>• Form the troop into open columns of patrols.</li> <li>• Hold a uniform inspection.</li> <li>• Repeat the Outdoor Code.</li> </ul>		
<b>Skills Instruction</b> _____ minutes	<ul style="list-style-type: none"> <li>• New Scouts work on tying the half hitch, taut-line and clove hitches, square knot, and bowline. Play Knot-Tying Relay (under Games in <i>Troop Program Resources</i>*).</li> <li>• Experienced Scouts work on shear, diagonal, and square lashings. Disassemble when done.</li> <li>• Older Scouts work on a Venture patrol activity or study a topographic map of the troop campout area in order to lay out an orienteering course.</li> </ul>		
<b>Patrol Meetings</b> _____ minutes	Discuss plans for the campout this month and make sure everyone knows what their assignments are and what to bring for the campout. Scouts in the new-Scout patrol need to know what support they will provide for the campout. Any Scouts who have not been camping yet will need some extra help. All other patrols plan activities to work on advancement. Patrol leaders should review the interpatrol activities that will take place and decide what skills need to be worked on.		
<b>Interpatrol Activity</b> _____ minutes	Play Tangle Knot. (See the Games section of <i>Troop Program Resources</i> .* )		
<b>Closing</b> _____ minutes Total 90 minutes of meeting	<ul style="list-style-type: none"> <li>• Form the troop into patrols. Call the patrol leaders forward to give patrol yells.</li> <li>• Scoutmaster's Minute.</li> <li>• Retire colors.</li> </ul>	SM	
<b>After the Meeting</b>	The patrol leaders' council reviews the next meeting and plans for the troop campout. Begin work on next month's program feature.		

\*Troop Program Resources for Scout Troops and Varsity Teams, Supply No. 33588

# CAMPING

## TROOP MEETING PLAN

Date \_\_\_\_\_ Week 2

ACTIVITY	DESCRIPTION	RUN BY	TIME
<b>Preopening</b> _____ minutes	Meet outdoors. Have the Scouts practice pitching tents.		
<b>Opening Ceremony</b> _____ minutes	Recite the Outdoor Code.		
<b>Skills Instruction</b> _____ minutes	<ul style="list-style-type: none"> <li>• New Scouts continue practicing tent-pitching skills (<i>Boy Scout Handbook</i> and <i>Fieldbook</i>).</li> <li>• Experienced Scouts work on Leave No Trace camping methods and select some campsites based on a topographic map of the troop camping area. Play Remote Clove-Hitch Tying (under Games in <i>Troop Program Resources</i>*).</li> <li>• Older Scouts work on a Venture patrol activity, serve as instructors for other Scouts, or prepare necessary items for merit badge work that can be done during the campout.</li> </ul>		
<b>Patrol Meetings</b> _____ minutes	Review assignments for the campout. First-time campers continue working on troop procedures for camping. All other patrols continue to work on activities for advancement on the campout. Practice interpatrol activities.		
<b>Interpatrol Activity</b> _____ minutes	Do Tent-Pitching Contest. (See the Games section of <i>Troop Program Resources</i> .*)		
<b>Closing</b> _____ minutes Total 90 minutes of meeting	<ul style="list-style-type: none"> <li>• Scoutmaster's Minute.</li> <li>• Retire colors.</li> </ul>	SM	
<b>After the Meeting</b>	The patrol leaders' council reviews the next meeting and plans for the troop campout. Work on next month's program feature.		

\*Troop Program Resources for Scout Troops and Varsity Teams, Supply No. 33588

# CAMPING

## TROOP MEETING PLAN

Date \_\_\_\_\_ Week 3

ACTIVITY	DESCRIPTION	RUN BY	TIME
<b>Preopening</b> _____ minutes			
<b>Opening Ceremony</b> _____ minutes			
<b>Skills Instruction</b> _____ minutes	<ul style="list-style-type: none"> <li>• New Scouts practice reading topographic maps and review what to do if lost (<i>Boy Scout Handbook</i>).</li> <li>• Experienced Scouts work on first-aid treatment for blisters, sprains, and other minor injuries possible during a campout.</li> <li>• Older Scouts work on a Venture patrol activity or plan an orienteering course for the campout, using a topographic map of the camping area.</li> </ul>		
<b>Patrol Meetings</b> _____ minutes	Finalize the menu for the campout and make sure everyone knows what to bring. Review clothing and equipment needs and collect any necessary fees. If you need to have a shake-down campout with your patrol or an outdoor practice for the patrol activities, schedule it now. Older Scouts might want to shoot photos or slides at the campout to add to your troop's scrapbook or to show at your next family gathering.		
<b>Interpatrol Activity</b> _____ minutes	Play Blindfold Compass Walk. (See the Games section of <i>Troop Program Resources</i> .)		
<b>Closing</b> _____ minutes Total 90 minutes of meeting	<ul style="list-style-type: none"> <li>• Scoutmaster's Minute.</li> <li>• Retire colors.</li> </ul>	SM	
<b>After the Meeting</b>	The patrol leaders' council reviews the next meeting and plans for the troop campout. Continue work on next month's program feature.		

\*Troop Program Resources for Scout Troops and Varsity Teams, Supply No. 33588

# CAMPING

## TROOP MEETING PLAN

Date \_\_\_\_\_ Week 4

ACTIVITY	DESCRIPTION	RUN BY	TIME
<b>Preopening</b> _____ minutes			
<b>Opening Ceremony</b> _____ minutes			
<b>Skills Instruction</b> _____ minutes	<ul style="list-style-type: none"> <li>• New Scouts work on the safe transport, fueling, and use of camp stoves. Review Leave No Trace camping guidelines.</li> <li>• Experienced Scouts work on map-and-compass skills in preparation for the orienteering course laid out for the camping trip. Review Leave No Trace camping guidelines.</li> <li>• Older Scouts work on a Venture patrol activity or assist in map-and-compass activities. They might lead the review of Leave No Trace camping guidelines.</li> </ul>		
<b>Patrol Meetings</b> _____ minutes	Review plans and assignments for the campout. Make sure everyone knows the travel plans and equipment needs. Go over the patrol duties roster. Practice interpatrol activities that will take place.		
<b>Interpatrol Activity</b> _____ minutes	Play Swat 'Em (See the Games section of <i>Troop Program Resources</i> .)		
<b>Closing</b> _____ minutes Total 90 minutes of meeting	<ul style="list-style-type: none"> <li>• Scoutmaster's Minute.</li> <li>• Retire colors.</li> </ul>	SM	
<b>After the Meeting</b>	The patrol leaders' council reviews the next meeting and any last-minute details for the troop campout. Finalize work on next month's program feature.		

\*Troop Program Resources for Scout Troops and Varsity Teams, Supply No. 33588



# CAMPING

## TROOP OUTDOOR PROGRAM PLAN

**Date** \_\_\_\_\_

TIME	ACTIVITY	RUN BY
<b>Friday evening</b>	Hike to campsite. Set up camp, stow gear, have an easily prepared meal.	SPL
<b>Saturday</b> 6:30 A.M.	Cooks and assistants prepare breakfast. (Cooks should be working on First and Second Class requirements.)	Cooks, assistants
7:00 A.M.	Everyone else gets up. Take care of personal hygiene, air tents, and hang out sleeping bags.	
7:30 A.M.	Breakfast.	
8:00 A.M.	Clean up.	Cooks
	Patrols put up the gear for morning activities; clean up patrol site.	
8:30–11:30 A.M.	Patrol competitions (from the Games section of <i>Troop Program Resources*</i> ) <ul style="list-style-type: none"> <li>• Blindfold Compass Walk</li> <li>• Knot-Tying Relay</li> <li>• Flagpole Raising</li> <li>• String-Burning Race</li> </ul>	SPL
11:30 A.M.	Cooks prepare lunch.	Cooks
Noon	Lunch.	
12:30 P.M.	Clean up.	Cooks
1:30 P.M.	Patrol competitions (from the Games section of <i>Troop Program Resources*</i> ) <ul style="list-style-type: none"> <li>• Remote Clove-Hitch Tying</li> <li>• Nature Scavenger Hunt</li> <li>• Roman Chariot Race</li> <li>• Capture the Flag</li> </ul>	
4:30 P.M.	Start dinner preparation.	Cooks
5:30 P.M.	Dinner.	SPL
6:00 P.M.	Clean up.	Cooks
8:00 P.M.	Begin evening program.	SPL
9:00 P.M.	Bedtime snack.	
10:00 P.M.	Lights out.	
<b>Sunday</b> 6:30 A.M.	Cooks and assistants prepare breakfast. (Cooks should be working on First and Second Class requirements.)	Cooks, assistants
7:00 A.M.	Everyone else gets up. Take care of personal hygiene, air tents, and hang out sleeping bags.	

*\*Troop Program Resources for Scout Troops and Varsity Teams, Supply No. 33588*

<b>TIME</b>	<b>ACTIVITY</b>	<b>RUN BY</b>
7:30 A.M.	Breakfast.	
8:00 A.M.	Clean up.	Cooks
	Patrols put up the gear for morning activities; clean up patrol site.	
8:30 A.M.	Religious service.	
9:00–11:00 A.M.	Patrol games—use four from the Games section of <i>Troop Program Resources</i> *)	
11:00 A.M.	Break camp.	
<b>Special equipment needed</b>	Topographic maps, clipboards, compasses, troop camping equipment.	

\**Troop Program Resources for Scout Troops and Varsity Teams*, Supply No. 33588

# CITIZENSHIP

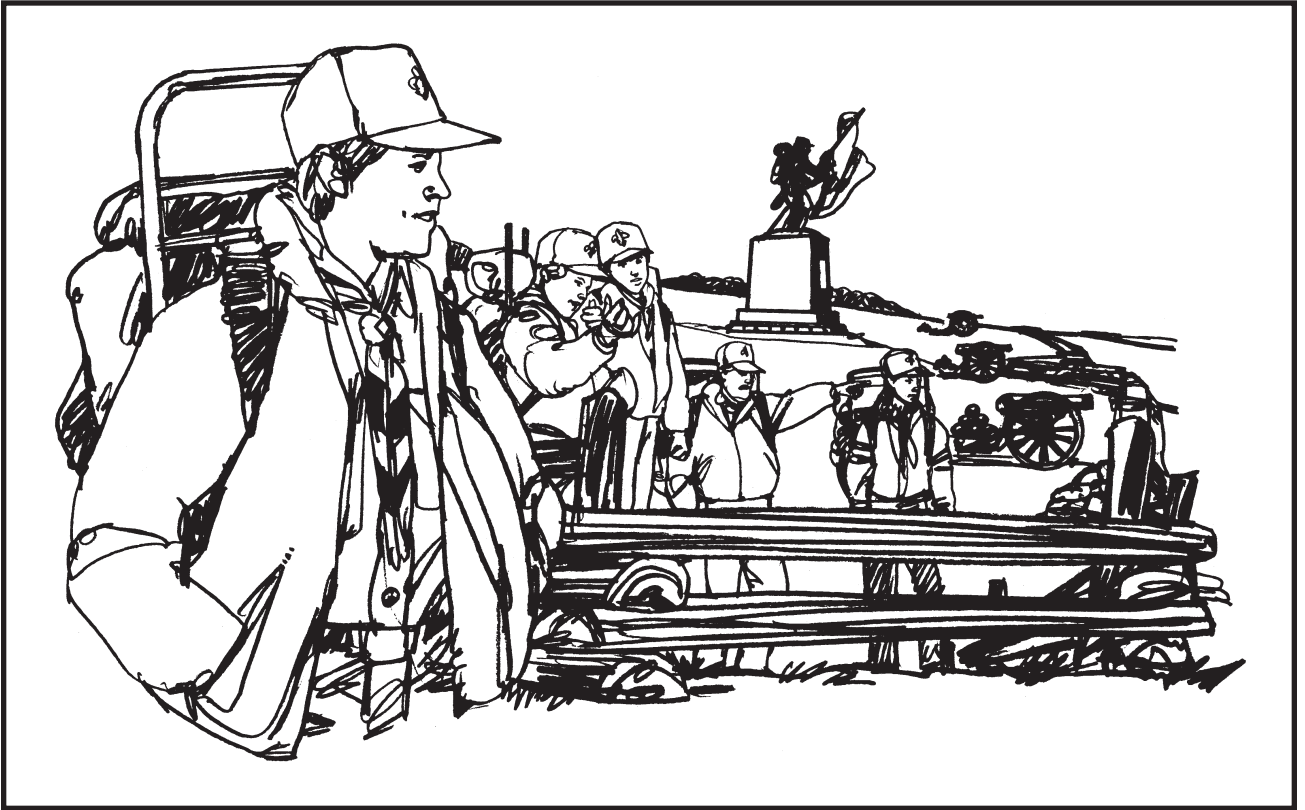

A primary aim of the Boy Scouts of America is to guide youth toward good citizenship. That goal is clearly expressed in the Scout Oath pledges of “duty to God and my country” and “to help other people at all times.” The 12 points of the Scout Law are virtually a checklist for good citizenship.

The citizenship program feature is designed to heighten a Scout’s appreciation of his rights and duties as a citizen, to make him aware of his heritage as an American, and to acquaint him with the approved ways of displaying and showing respect for the chief symbol of our country—the flag. The suggested troop meeting plans also include elements that apply to related merit badges including Citizenship in the Community, Citizenship in the Nation, American Cultures, and American Heritage.

As one highlight of the month, the troop could plan to attend a meeting of a public body such as the city council or school board, or a gathering of a private group that is concerned with the public welfare, such as a tenants’ or homeowners’ association or neighborhood block-watch group. (Obviously the troop schedule will have to be adapted to the schedule of the council, board, or group.) While planning the event, the patrol leaders’ council can arrange for an official or officer of the group to answer questions after the meeting.

The troop’s big event will be a heritage hike. The destination might be a historic site or trail in your troop’s area. Or it could be a place that is significant to the heritage of your region—a wildlife refuge, an unusual geological formation, a zoo, or the location of an ethnic festival. The heritage hike can be a day outing or an overnight campout.

## SCOUTING OUTCOMES

This month’s patrol and troop activities should give your Scouts

- A greater understanding of their duty to country and their obligation to help other people
- Awareness of their rights and responsibilities as citizens
- Some knowledge of their heritage as citizens of their community and nation
- Growth in self-confidence
- Increasing ability to work cooperatively with others in an outdoor setting

## ADVANCEMENT OPPORTUNITIES

By the end of the month, all Scouts should have met the majority of their citizenship requirements through First

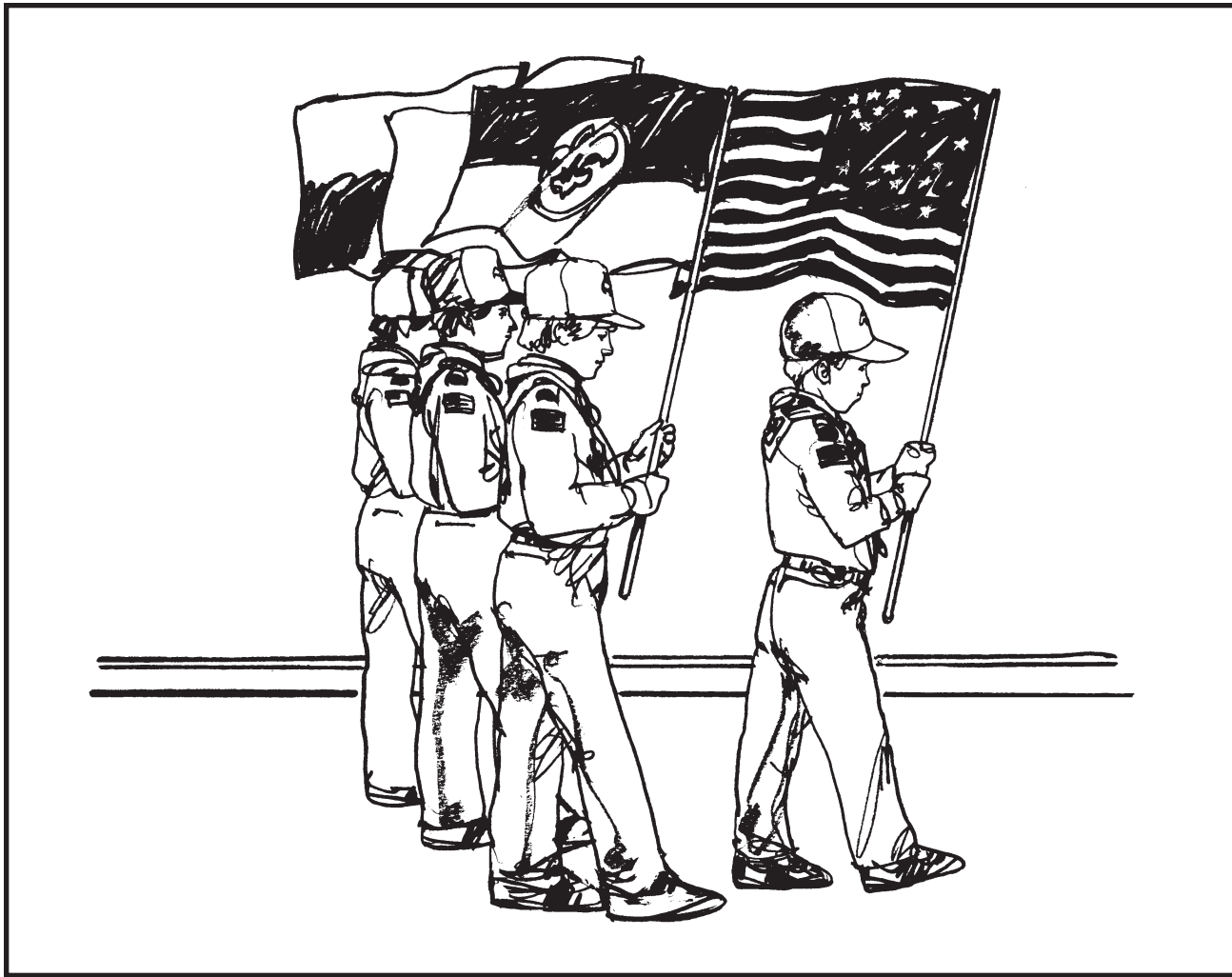

Class rank. Depending on the activities, they might also complete all or part of the following rank requirements:

*Tenderfoot*

- Outdoor—hiking, camping
- Citizenship—flag ceremonies, Good Turn
- Patrol/troop participation—patrol identification
- Personal development—Scout Oath and Law

*Second Class*

- Outdoor—cooking, camping, hiking
- Citizenship—flag ceremonies
- Patrol/troop participation—leadership
- Personal development—Scout Oath and Law

*First Class*

- Outdoor—cooking, camping, nature, hiking
- Citizenship—flag ceremonies, Good Turn
- Patrol/troop participation—leadership

- Personal development—Scout Oath and Law

*Merit Badges.* Older Scouts should be able to complete some of the requirements for one or more of the Citizenship merit badges. Depending on activities during the month, they might also complete some of the requirements for American Cultures, American Heritage, Camping, Cooking, Hiking, and other outdoor-related merit badges.

**PARENT/GUARDIAN PARTICIPATION**

The patrol leaders' council can involve parents and guardians in the program feature this month by

- Asking qualified parents and guardians to help with troop meeting instruction (Give special consideration to those involved in public positions—lawyers, history teachers, law enforcement officials, journalists, etc.)
- Inviting parents and guardians on the heritage hike

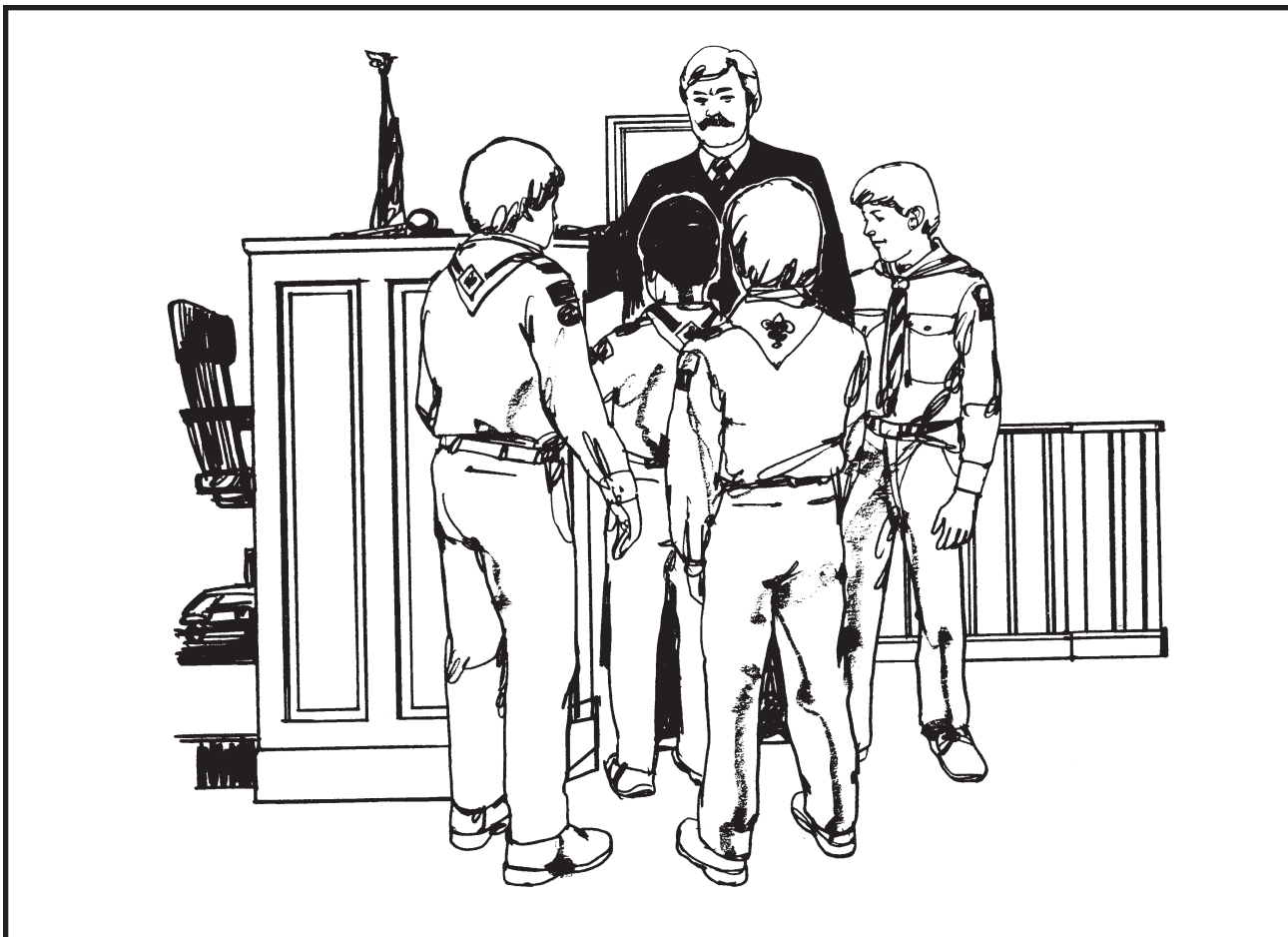

- Asking them to provide transportation for the visit to a community meeting or to and from the starting point of the hike

### **PATROL LEADERS' COUNCIL**

The patrol leaders' council should have met in the middle of the previous month to plan troop activities for this program feature. If they didn't complete all of the items on the following agenda, they can continue planning at brief patrol leaders' council meetings after each troop meeting.

- Decide which public body or private organization the troop will visit during the month. Assign a member to check on the date, time, and place of the meeting, and arrange to have an official meet with the troop either beforehand or afterward. (The patrol leaders' council may ask an adult on the troop committee to make these arrangements if that is more appropriate.)
- Make arrangements to invite a community leader to the second troop meeting of the month to discuss his or her work and to lead a discussion on the rights and duties of a citizen. The person could be a mayor, city council member, school board member, city attorney, judge, or the leader of a civic or service group.
- Make patrol assignments for the following troop meeting activities:
  - Perform the opening and closing flag ceremonies.
  - Give a presentation on the history of the U.S. flag.
  - Report on the history or significance of the destination of the heritage hike.
  - Lead a discussion on the rights of Scout-age youth—including the right to be protected from assault and theft, to inform authorities if someone is being treated unjustly, to use public facilities on the same basis as all other citizens, and to have adequate food and shelter. Also discuss the duties of young people, including the duty to attend school, to complete schoolwork to the best of their ability, to pay for public services on the same basis as other citizens, to avoid littering or damaging public and private property, and to follow traffic rules while bicycling. (See the *Boy Scout Handbook* for more ideas.)

- Make a list of possible patrol Good Turns for the community. (For ideas and guidelines, see chapter 19, “Community Service,” and “Conservation Projects” in chapter 9, “The Outdoor Program,” in the *Scoutmaster Handbook*. The BSA’s *Conservation Handbook* contains plenty of information about meaningful ways Scouts can complete projects on public and private lands.)

## **BIG EVENT**

### **The Heritage Hike**

As with most other Scouting activities, this big event should be fun. It should have an educational purpose, too, although not in a classroom sense.

The aim is to introduce Scouts to some aspect of their American heritage. It might be a historic site of local, regional, or national interest. It could be a place where Scouts can bask in America’s beauty or be awed by the nation’s natural wonders—perhaps a pristine lake, a wildlife refuge, a canyon or mesa, or an ancient forest. If this program feature occurs during a national holiday, your “hike” might take the form of participation in a parade, an ethnic festival, or other fitting event.

The big event can be a day outing or an overnight campout. Based on the patrols’ interests, the patrol leaders’ council should determine the distance to be covered and the location of the destination or campsite. An overnight stay increases the possibilities for Scouts to complete outdoor-oriented rank and merit badge requirements.

The senior patrol leader could assign a patrol the task of researching some facts about the heritage hike destination and reporting to the troop on its history and significance. For example, if the troop is going to a historic site, what can the Scouts expect to see? What happened at the site? This kind of advance information will enhance the experience for the Scouts, especially if there will not be a local guide at the site.

### **Historic Trail Hike**

In most states Scouts can find historic trails marked and waiting for troops to enjoy. More than 250 such trails have been approved by the Boy Scouts of America for their historical significance and the condition in which they are maintained. For a list of these trails, see <http://www.scouting.org>, or contact your local council service center or the National Parks Service.

## **LEARNING THE PUBLIC’S BUSINESS**

The troop meeting plan for week three suggests that the troop visit a meeting of a public body, a private organization that works for the public welfare, or some other agency or group that affects the lives of citizens. The goal is to show Scouts American democracy in action. Here are several possibilities:

- City council
- School board
- Municipal court
- County court for a naturalization ceremony
- Tenants’ or homeowners’ association or neighborhood block-watch group

At meetings of this type, it is essential that the presiding officer or other knowledgeable person meet with the troop either before or after the regular meeting to explain the proceedings. If not, the meeting’s business might not make much sense to Scouts.

Check ahead of time with those in charge of the meeting to determine the expected length of the session. The meetings of some city councils and school boards can last for hours, much longer than the attention span of most boys. Arrange to have troop members attend a particular portion of the meeting that is most likely to hold their interest, and then have them quietly file out. The “public comment” section of a meeting is often lively and entertaining.

At the troop meeting following the visit, encourage Scouts to discuss what they saw and heard. Reinforce the idea that the meeting was a demonstration of *representative democracy*—the way Americans govern themselves.

## **OTHER SPECIAL ACTIVITIES**

If the troop is using this feature around Memorial Day (last Monday in May) or Independence Day (July 4), the patrol leaders’ council might want to observe the holiday by encouraging display of the U.S. flag or by taking part in local celebrations. The troop might march in a parade, assist at a ceremony, perform a public display of flag courtesies, or distribute fliers to remind residents when and how to fly the flag.

# CITIZENSHIP

## TROOP MEETING PLAN

Date \_\_\_\_\_ Week 1

ACTIVITY	DESCRIPTION	RUN BY	TIME
<b>Preopening</b> _____ minutes	Have a pair of experienced Scouts show how to fold and care for the U.S. flag ( <i>Boy Scout Handbook</i> ).		
<b>Opening Ceremony</b> _____ minutes	<ul style="list-style-type: none"> <li>• Form the troop into parallel patrols.</li> <li>• Present the colors.</li> <li>• Sing the national anthem.</li> <li>• Hold a uniform inspection.</li> </ul>		
<b>Skills Instruction</b> _____ minutes	<ul style="list-style-type: none"> <li>• New Scouts practice raising, lowering, and folding the flag. Plan and rehearse an opening ceremony to use at next week's meeting.</li> <li>• Experienced Scouts visit a fire or police station to find out how they operate and what it takes to become a police officer or fire fighter.</li> <li>• Older Scouts work on a Venture patrol activity or start planning the troop heritage hike. Consider planning several stops that are of historical importance to your community.</li> </ul>		
<b>Patrol Meetings</b> _____ minutes	Discuss plans for a patrol outing this month. This outing could be a five- or 10-mile hike so that newer Scouts can work on their hiking skills. Or plan a patrol Good Turn. Consider working on items that Scouts need to advance to the next rank.		
<b>Interpatrol Activity</b> _____ minutes	Play "Rooster Fight." (See the Games section of <i>Troop Program Resources</i> .* )		
<b>Closing</b> _____ minutes Total 90 minutes of meeting	<ul style="list-style-type: none"> <li>• Form the troop into patrols and sing "God Bless America."</li> <li>• Scoutmaster's Minute.</li> <li>• Retire colors.</li> </ul>	SM	
<b>After the Meeting</b>	The patrol leaders' council reviews the next meeting and plans for the troop outing. Begin work on next month's program feature.		

\*Troop Program Resources for Scout Troops and Varsity Teams, Supply No. 33588

# CITIZENSHIP

## TROOP MEETING PLAN

Date \_\_\_\_\_ Week 2

ACTIVITY	DESCRIPTION	RUN BY	TIME
<b>Preopening</b> _____ minutes			
<b>Opening Ceremony</b> _____ minutes			
<b>Skills Instruction</b> _____ minutes	<ul style="list-style-type: none"> <li>• New Scouts meet with an elected public official, either at the troop meeting place or in his or her office. Learn what the official does and how an election is conducted.</li> <li>• Experienced Scouts plan a simple community Good Turn project (chapter 19, "Community Service," in the <i>Scoutmaster Handbook</i>).</li> <li>• Older Scouts work on a Venture patrol activity or, if possible, prepare for a campout on the troop heritage hike.</li> </ul>		
<b>Patrol Meetings</b> _____ minutes	Identify Scouts in the patrol who need to participate in flag ceremonies and Good Turn projects. Suggest activities that these Scouts can participate in to fulfill rank requirements.		
<b>Interpatrol Activity</b> _____ minutes	Play any of the "Steal-the-Bacon" games suitable for patrol teams. (See the Games section of <i>Troop Program Resources</i> .*)		
<b>Closing</b> _____ minutes Total 90 minutes of meeting	<ul style="list-style-type: none"> <li>• Scoutmaster's Minute.</li> <li>• Retire colors.</li> </ul>	SM	
<b>After the Meeting</b>	The patrol leaders' council reviews the next meeting and plans for the troop outing. Work on next month's program feature.		

\*Troop Program Resources for Scout Troops and Varsity Teams, Supply No. 33588



# CITIZENSHIP

## TROOP MEETING PLAN

Date \_\_\_\_\_ Week 3

ACTIVITY	DESCRIPTION	RUN BY	TIME
<b>Preopening</b> _____ minutes			
<b>Opening Ceremony</b> _____ minutes			
<b>Skills Instruction</b> _____ minutes	<ul style="list-style-type: none"> <li>• Visit a public agency such as a night court, city council meeting, or a school board meeting.</li> <li>• Find out how the agency fits into the economy of your community, the country, or the world.</li> <li>• See how the government operates.</li> </ul>		
<b>Patrol Meetings</b> _____ minutes			
<b>Interpatrol Activity</b> _____ minutes			
<b>Closing</b> _____ minutes Total 90 minutes of meeting	<ul style="list-style-type: none"> <li>• Scoutmaster's Minute.</li> <li>• Retire colors.</li> </ul>	SM	
<b>After the Meeting</b>	The patrol leaders' council reviews the next meeting and plans for the troop outing. Continue work on next month's program feature.		

# CITIZENSHIP

## TROOP MEETING PLAN

Date \_\_\_\_\_ Week 4

ACTIVITY	DESCRIPTION	RUN BY	TIME
<b>Preopening</b> _____ minutes			
<b>Opening Ceremony</b> _____ minutes			
<b>Skills Instruction</b> _____ minutes	<ul style="list-style-type: none"> <li>• New Scouts work on projects related to citizenship.</li> <li>• Experienced Scouts review map-and-compass skills in preparation for the heritage hike.</li> <li>• Older Scouts work on a Venture patrol activity, assist with map-and-compass activities, or continue planning for the troop heritage hike (and campout, if approved).</li> </ul>		
<b>Patrol Meetings</b> _____ minutes	Review plans and assignments for the historic hike. Make sure everyone knows the travel plans and equipment needs. Practice interpatrol activities.		
<b>Interpatrol Activity</b> _____ minutes	Select a game from <i>Troop Program Resources</i> . Pick a game that will require teamwork within each patrol.		
<b>Closing</b> _____ minutes  Total 90 minutes of meeting	<ul style="list-style-type: none"> <li>• Scoutmaster's Minute.</li> <li>• Retire colors.</li> </ul>	SM	
<b>After the Meeting</b>	The patrol leaders' council reviews the next meeting and last-minute details for the troop outing. Finalize work on next month's program feature.		

\*Troop Program Resources for Scout Troops and Varsity Teams, Supply No. 33588

# CITIZENSHIP

## TROOP OUTDOOR PROGRAM PLAN

**Date** \_\_\_\_\_

TIME	ACTIVITY	RUN BY
<b>Friday evening</b>	Load gear at meeting location; leave for campsite. Plan only a light meal en route.	SPL
	Arrive at campsite; off-load equipment. Set up patrol sites. Stow gear and set up camp. Prepare camp stoves for breakfast.	SPL/PL
<b>Saturday</b> 6:30 A.M.	Cooks and assistants prepare breakfast. (Cooks should be working on First and Second Class requirements.)	Cooks, assistants
7:00 A.M.	Everyone else gets up. Take care of personal hygiene, air tents, and hang out sleeping bags.	
7:30 A.M.	Breakfast.	
8:00 A.M.	Clean up.	Cooks
	Patrols put up the gear for morning activities; clean up patrol site.	
8:30–11:30 A.M.	Give patrol leaders a topographic map to lead a three- to five-mile hike. Scouts working toward First Class rank could take part in an orienteering race. Younger Scouts could take a nature hike.	SPL
11:30 A.M.	Sack lunch.	
Noon	Continue activities.	
4:30 P.M.	Start dinner preparation.	Cooks
5:30 P.M.	Dinner.	SPL
6:00 P.M.	Clean up.	Cooks
8:00 P.M.	Campfire.	
9:00 P.M.	Bedtime snack.	
10:00 P.M.	Lights out.	
<b>Sunday</b> 6:30 A.M.	Cooks and assistants prepare breakfast. (Cooks should be working on First and Second Class requirements.)	Cooks, assistants
7:00 A.M.	Everyone else gets up. Take care of personal hygiene, air tents, hang out sleeping bags.	
7:30 A.M.	Breakfast.	
8:00 A.M.	Clean up.	Cooks
	Patrols put up the gear for morning activities; clean up patrol site.	

TIME	ACTIVITY	RUN BY
8:30 A.M.	Worship service.	
9:00–11:00 A.M.	Patrol games—use four from the Games section of <i>Troop Program Resources</i> . *	
11:00 A.M.	Break camp.	
<b>Special equipment needed</b>	Topographic maps, clipboards, compasses, troop camping equipment.	

\**Troop Program Resources for Scout Troops and Varsity Teams*, Supply No. 33588

# COMMUNICATIONS

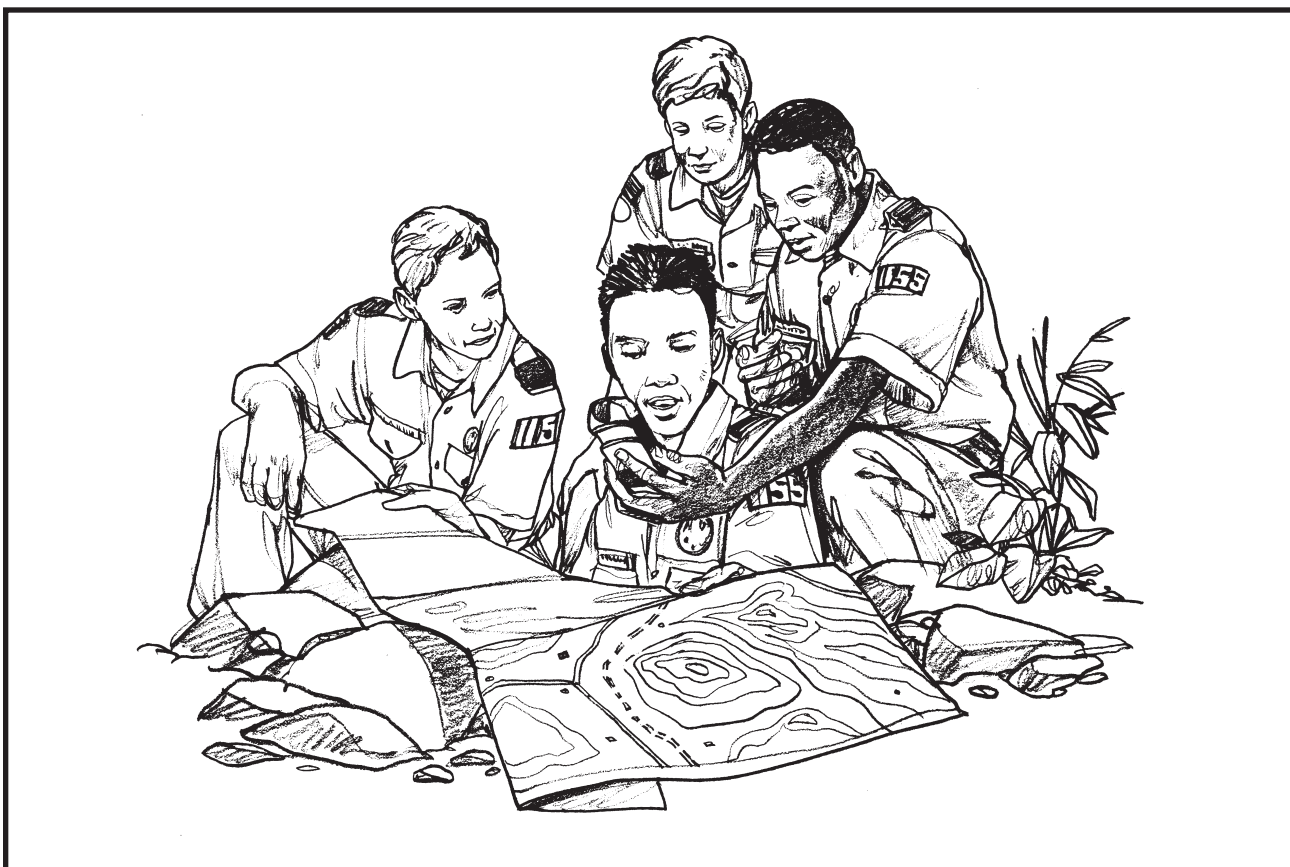

Every human is constantly communicating through speech, reading, body language, even a raised eyebrow. We have many other means of sending and receiving messages, too—the telephone, television, radio, photographs and drawings, computers, recorded tapes, and compact discs.

This month your Scouts can explore some of the older means of communication such as Morse code, flags, and sign language. Each patrol might want to become proficient in one means of communication and teach it to the others.

The big event will be a send-the-word campout. Besides having contests in communications skills, the troop can also work on other outdoor and nature skills. To top off your activities, you will want to have a troop campfire that provides an opportunity to use various means of communication.

## SCOUTING OUTCOMES

This month's patrol and troop activities should give your Scouts

- The knowledge and skills to be comfortable in a variety of communications methods
- A sense of communion with nature and God

- A greater respect for the outdoors and a determination to follow the Outdoor Code
- Enhanced self-confidence
- Enhanced camping skills

## ADVANCEMENT OPPORTUNITIES

Depending on the campout activities, all Scouts may complete all or part of the following rank requirements:

### *Tenderfoot*

- Outdoor—cooking, camping
- Citizenship—flag ceremonies
- Patrol/troop participation—patrol identification
- Personal development—Scout Oath and Law

### *Second Class*

- Outdoor—cooking, camping
- Citizenship—flag ceremonies
- Patrol/troop participation—patrol identification
- Personal development—Scout Oath and Law
- Physical fitness—drug awareness



*First Class*

- Outdoor—cooking, camping, nature, hiking
- Citizenship—flag ceremonies
- Patrol/troop participation—patrol identification
- Personal development—Scout Oath and Law

*Merit Badges.* Older Scouts can concentrate on the Communication and Computers merit badges this month; they should be able to complete many of the requirements. Depending on activities during the campout, they may also complete requirements in Camping, Cooking, Hiking, and other outdoor-related merit badges.

**PARENT/GUARDIAN PARTICIPATION**

The patrol leaders’ council can involve parents in the program feature this month by

- Asking qualified parents to assist with instruction for computer and signaling skills
- Inviting parents on the campout

- Asking parents to provide transportation to the starting point for the backpacking trek into camp, if necessary
- Getting help in arranging to visit communications businesses such as television and radio stations and computer centers

**PATROL LEADERS’ COUNCIL**

The patrol leaders’ council should meet during the early part of the previous month to plan troop activities for this program feature. If you don’t complete all items on the following agenda, continue planning at patrol leaders’ council meetings after each troop meeting.

- Decide on the campsite for the send-the-word campout. If permissions will be needed, assign someone to secure them.
- Plan the special activities for the campout. See the ideas on these pages. If special gear or tools will be needed, assign someone to obtain them; seek help from the troop committee, if necessary.

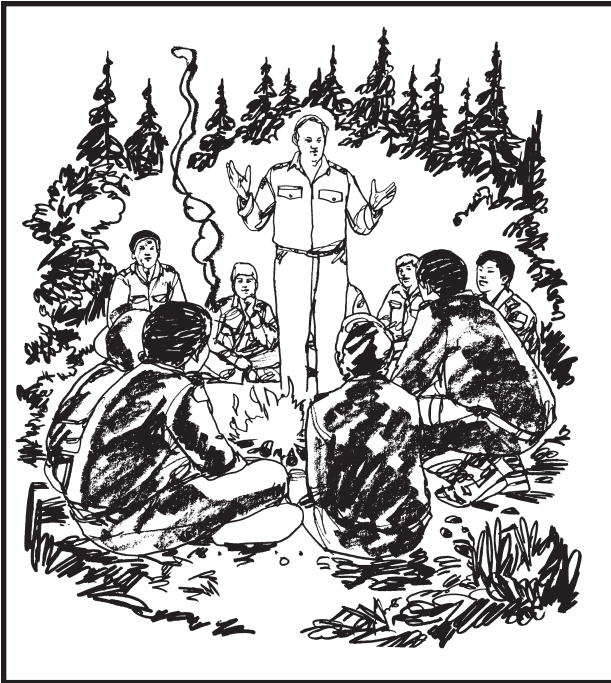

- Inventory the troop's camping equipment, if not done recently.
- Plan details of troop meetings for the month. Assign patrol demonstrations, covering skills that will be needed for the campout activities. For example:

**Patrol A**—Morse code with mirrors or flashlights

**Patrol B**—trail signs

**Patrol C**—sign language

- Have an activity where Scouts working on the Communication merit badge can give a demonstration.

## FEATURE EVENT

### Send-the-Word Campout

The primary purpose of this outing is to use communications skills and have some fun. The skills you have been working on all month will now come into play.

Games and activities can be set up using certain communications skills to achieve particular goals. These activities can take place day or night, and they provide an opportunity for related activities. As an example, you might have an orienteering course where each station has directions written in Morse code.

Each patrol will have an opportunity to instruct the rest of the troop in the communications skill it has learned.

## Campout Activities

Obviously the activity schedule will depend on the weather and the length of your campout. There are many possibilities for activities for the campout. Besides working on communications skills, Scouts might work on cooking, camping, and nature skills. Climax the activities with a troop campfire.

The following are some good contests for communications practice:

### GET THE MESSAGE

**Equipment:** Signal flag for each patrol, paper and pencil for each Scout, secret message for each patrol to send.

**Method:** Each patrol has one signaler and one dictator. These two players are sent 100 yards or more away from the rest of the patrol and given a secret message of 30 letters.

Each receiver in the patrol writes the message on his paper. (There must be no communication between receivers in the patrol.) The signaler may not repeat the message, but he may send it slowly enough to be understood by all his patrol members. When the message is completed, the patrol leader collects the slips for the judge.

**Scoring:** Correct letters received by all patrol members are added together, then divided by the number of receivers to get the patrol average. The patrol with the highest average wins.

**Variation:** This same game could be played at night using flashlights and Morse code or during the daytime using mirrors.

### MESSAGE RELAY

**Equipment:** None.

**Method:** A leader gives a message to a Scout, using sign language. The Scout must relay it to the next member in his patrol and so forth, until the last member of the patrol repeats it to the leader.

**Scoring:** The patrol getting the most words correct wins.

### WHO'S THAT?

**Equipment:** None.

**Method:** A nocturnal hunt sometimes shows people as they aren't. In an outdoor setting, split the troop in half. One team will be Hiders, the others Seekers. The Hiders go outside to a well-known or an established trail, not far from the main cabin or building, but not with dense cover. No street lamps or building lights should be visible.

Tell the Hiders that motionless people in the dark may take on other forms that appear to be rocks,

stumps, or logs. Indicate that, as Hiders, they should cover all parts of their body that stand out (skin or clothing), and camouflage their body to blend with surroundings. They then begin hiding along the trail, following these rules and guidelines:

- Hide people individually unless there is reluctance to stay alone; if there is, allow a pair to hide together.
- A Hider must be in a partially exposed position. Completely concealing a person behind something is not allowed. The Hider should try to blend in with the natural surroundings; a rock, tree, stump, etc. A Hider must be no more than 20 feet away from the trail.

The Seekers wait patiently in the building until the leader of the Hiders returns and announces that all is ready. Seekers should follow these guidelines:

- The object of the game is to find as many Hiders as possible.
- Point scores are kept for each team.
- The Seekers are taken to the trailhead and told that from here on, they can expect to find hidden people on each side of the trail.
- The Seekers must stay on the trail.
- When someone thinks he has spotted a Hider, he calls others over to have a look. If the consensus is that there is actually someone there, the attending instructor shines his flashlight directly at the spot indicated by the Seekers. If a Hider is revealed, the Seekers get a point. If no one is there, the Hiders get a point.
- If all of the Seekers pass a Hider on the trail, the instructor calls the group back and points out the Hider with a flashlight. The Hiders then get a point, and that particular Hider may join the group and silently cheer on his group.

This procedure continues until the last Hider has been found or is revealed. Points are tallied. The teams then reverse roles and the game is played again.

The reason the Seekers remain indoors until the Hiders are set is to show how night vision helps make

walking in the dark a little safer. The exercise is a natural lead-in to a discussion about how nocturnal animals can see in reduced light. Mention bats, owls, and cats.

Do not allow any flashlights to be carried, except by the leader.

**Variation:** The trail could be laid out using trail signs.

### **Your Campfire Program**

A troop campfire program should have elements of fun, inspiration, and good fellowship. Each Scout should leave with pleasant memories.

The campfire doesn't have to be an elaborate production, but it does require planning. You will want lots of variety, including ceremonies, songs, skits and stunts, games, and usually a Scoutmaster's Minute. The general rule is that the campfire program "follows the fire." That is, while the fire is blazing, you have lively songs, games, and skits. As the fire dies, you have inspirational songs, the Scoutmaster's Minute, and other more serious elements.

In many troops, the patrol leaders' council plans the campfire and assigns elements to each patrol. In others, one patrol is assigned to build the fire lay and another to plan the program. In either case, the Scoutmaster or another adult leader should stay in touch with the planners to make sure that many boys (not just the campfire planners) will have a part, and that all activities, stunts, and songs will be in good taste. If questions arise, the adult leader should make it clear that there is no place in Scouting for poor taste, poor manners, or hurting anyone in body or spirit.

The campfire planners should figure on a program lasting about an hour or a little less. It's better to end the program while the Scouts are having fun than to let it drag on until they become restless. One way to ensure a fast-moving, well-planned campfire is to use the Campfire Program Planner, No. 33696. With that sheet to guide them, the planners can estimate the time for each element and end the program accordingly.

If your troop has Scouts who have been to several big campfires at camporees, they will have lots of ideas for skits, stunts, and songs.



# COMMUNICATIONS

## TROOP MEETING PLAN

Date \_\_\_\_\_ Week 1

ACTIVITY	DESCRIPTION	RUN BY	TIME
<b>Preopening</b> _____ minutes	Have one or more computers set up for Scouts to use. Explain how they work and what they can do. Also, have a telegraph key to practice Morse code.		
<b>Opening Ceremony</b> _____ minutes	<ul style="list-style-type: none"> <li>• Form the troop using silent signals. Explain what you are doing, and at the next meeting use only silent signals to gather the troop.</li> <li>• Present colors.</li> <li>• Repeat the Pledge of Allegiance.</li> <li>• Repeat the Scout motto and slogan.</li> </ul>		
<b>Skills Instruction</b> _____ minutes	<ul style="list-style-type: none"> <li>• New Scouts work on basic map and compass skills for orienteering and measuring heights and distances. Do Direction-Finding Relay. (See the Games section of the <i>Troop Program Resources</i>.*)</li> <li>• Experienced Scouts work on three computer programming languages or prepare a flowchart to compute attendance and dues paid for the past five troop meetings.</li> <li>• Older Scouts work on the Venture program or prepare a drug awareness program for the troop that could be used as part of a troop opening or on the campout. The program should not last more than five minutes.</li> </ul>		
<b>Patrol Meetings</b> _____ minutes	Discuss plans for the campout this month and make sure everyone knows what his assignment is and what to bring for the campout. The new-Scout patrol needs to know what support it will provide for the campout. Any Scouts who have not been camping will need extra help. All other patrols plan activities to work on advancement. Patrol leaders should also review the interpatrol activities that will take place and the skills Scouts need to work on for them.		
<b>Interpatrol Activity</b> _____ minutes	Play Human Obstacle Race. (See the Games section of the <i>Troop Program Resources</i> .*)		
<b>Closing</b> _____ minutes Total 90 minutes of meeting	<ul style="list-style-type: none"> <li>• Repeat the Outdoor Code.</li> <li>• Scoutmaster's Minute.</li> <li>• Retire colors.</li> </ul>	SM	
<b>After the Meeting</b>	Patrol leaders' council reviews the next meeting and plans for the campout. Begin work on next month's program feature.		

\*Troop Program Resources for Scout Troops and Varsity Teams, Supply No. 33588

# COMMUNICATIONS

## TROOP MEETING PLAN

Date \_\_\_\_\_ Week 2

ACTIVITY	DESCRIPTION	RUN BY	TIME
<b>Preopening</b> _____ minutes			
<b>Opening Ceremony</b> _____ minutes			
<b>Skills Instruction</b> _____ minutes	<ul style="list-style-type: none"> <li>• New Scouts review how to pack for a hike and work on telling time without a watch. Play Silver Dollar Hunt. (See the Games section of the <i>Troop Program Resources</i>.*)</li> <li>• Experienced Scouts begin work on a campfire program for the campout, or if you have a court of honor in the near future, plan the program.</li> <li>• Older Scouts work on the Venture program or construct several heliographs to use on the outing.</li> </ul>		
<b>Patrol Meetings</b> _____ minutes	Review assignments for the campout. First-time campers continue working on basic camping techniques. All other patrols continue planning activities for advancement during the outing. Practice interpatrol activities.		
<b>Interpatrol Activity</b> _____ minutes	Do Blindfold Compass Walk. (See the Games section of the <i>Troop Program Resources</i> .*)		
<b>Closing</b> _____ minutes  Total 90 minutes of meeting	<ul style="list-style-type: none"> <li>• Scoutmaster's Minute.</li> <li>• Retire colors.</li> </ul>	SM	
<b>After the Meeting</b>	Patrol leaders' council reviews the next meeting and plans for the troop outing. Continue work on next month's program feature.		

\*Troop Program Resources for Scout Troops and Varsity Teams, Supply No. 33588

# COMMUNICATIONS

## TROOP MEETING PLAN

Date \_\_\_\_\_ Week 3

ACTIVITY	DESCRIPTION	RUN BY	TIME
<b>Preopening</b> _____ minutes			
<b>Opening Ceremony</b> _____ minutes			
<b>Skills Instruction</b> _____ minutes	<ul style="list-style-type: none"> <li>• New Scouts work on tying knots: two half hitches, tautline, bowline.</li> <li>• Experienced Scouts make semaphore flags and practice sending messages in code. Plan to tour a local television or radio station to see how it operates, or have local ham radio operators explain how they communicate around the world.</li> <li>• Older Scouts work on the Venture program or get a map of the campout area and lay out a nature trail. Plan to go early to mark the trail for the campout.</li> </ul>		
<b>Patrol Meetings</b> _____ minutes	Finalize the menu for the campout and make sure everyone knows what he will need to bring. Review clothing and equipment needs and collect any necessary fees. If you need to have a shakedown campout with your patrol or an outdoor practice for the patrol activities, schedule it now. Older Scouts can plan to take pictures at the campout to add to your troop's scrapbook, or plan to shoot slides to show at the troop's next family gathering.		
<b>Interpatrol Activity</b> _____ minutes	Play British Bulldog. (See the Games section of the <i>Troop Program Resources</i> .* )		
<b>Closing</b> _____ minutes  Total 90 minutes of meeting	<ul style="list-style-type: none"> <li>• Scoutmaster's Minute.</li> <li>• Retire colors.</li> </ul>	SM	
<b>After the Meeting</b>	Patrol leaders' council reviews the next meeting and plans for the outing. Continue work on next month's program feature.		

\*Troop Program Resources for Scout Troops and Varsity Teams, Supply No. 33588

# COMMUNICATIONS

## TROOP MEETING PLAN

Date \_\_\_\_\_ Week 4

ACTIVITY	DESCRIPTION	RUN BY	TIME
<b>Preopening</b> _____ minutes			
<b>Opening Ceremony</b> _____ minutes			
<b>Skills Instruction</b> _____ minutes	<ul style="list-style-type: none"> <li>• New Scouts work on building fires or making fire lays (<i>Boy Scout Handbook</i>).</li> <li>• Experienced Scouts work on map and compass skills and prepare an orienteering course for the campout. Practice pacing. Do Direction Hunt (see the Games section of the <i>Troop Program Resources</i>*), or continue work with semaphore flags.</li> <li>• Older Scouts work on the Venture program or assist in map and compass activities or in layout of an orienteering course for the campout.</li> </ul>		
<b>Patrol Meetings</b> _____ minutes	Review plans and assignments for the campout. Make sure everyone knows the travel plans and equipment needs. Review the patrol duty roster. Practice interpatrol activities that will take place.		
<b>Interpatrol Activity</b> _____ minutes	Play Hot Isotope Transport. (See the Games section of the <i>Troop Program Resources</i> .* )		
<b>Closing</b> _____ minutes Total 90 minutes of meeting	<ul style="list-style-type: none"> <li>• Scoutmaster's Minute—reflection on the experiences of the month.</li> <li>• Retire colors.</li> </ul>	SM	
<b>After the Meeting</b>	Patrol leaders' council reviews the next meeting and checks last-minute details for the troop outing. Finalize work on next month's program feature.		

\*Troop Program Resources for Scout Troops and Varsity Teams, Supply No. 33588

# COMMUNICATIONS

## TROOP OUTDOOR PROGRAM PLAN

**Date** \_\_\_\_\_

TIME	ACTIVITY	RUN BY
<b>Friday evening</b>	Load gear at meeting location, leave for campsite. Plan only a light meal en route.	SPL
	Arrive at campsite; off-load equipment. Set up patrol sites. Stow gear and set up camp.	SPL
<b>Saturday</b> 6:30 A.M.	Cooks and assistants up. Prepare breakfast. (Cooks should be working on First and Second Class requirements.)	Cooks, assistants
7:00 A.M.	Everyone else up. Take care of personal hygiene, air tents, hang out sleeping bags.	
7:30 A.M.	Breakfast	
8:00 A.M.	Clean up.	Cooks
	Patrols put up the gear for morning activities, clean up patrol site.	
8:30–11:30 A.M.	Patrol competitions—signaling instruction and games; younger Scouts take nature hike.	SPL
11:30 A.M.	Cooks prepare lunch.	Cooks
Noon	Lunch	
12:30 P.M.	Clean up.	Cooks
1:30 P.M.	Continue competitions—play Capture the Flag. (See the Games section of the <i>Troop Program Resources</i> .)	
4:30 P.M.	Start dinner preparation.	Cooks
5:30 P.M.	Dinner	SPL
6:00 P.M.	Clean up.	Cooks
8:00 P.M.	Nighttime activity using communications game	
9:00 P.M.	Campfire program planned by experienced Scouts	SPL
10:00 P.M.	Cracker barrel	
11:00 P.M.	Lights out	
<b>Sunday</b> 7:00 A.M.	Cooks and assistants up. Prepare breakfast. (Cooks should be working on First and Second Class requirements.)	Cooks, assistants
7:30 A.M.	Everyone else up. Take care of personal hygiene needs, air tents, hang out sleeping bags.	

*\*Troop Program Resources for Scout Troops and Varsity Teams, Supply No. 33588*

<b>TIME</b>	<b>ACTIVITY</b>	<b>RUN BY</b>
8:00 A.M.	Breakfast	
8:30 A.M.	Clean up.	Cooks
	Patrols put up the gear for morning activities, clean up patrol site.	
9:00 A.M.	Worship service	
9:30–11:00 A.M.	Patrol games. Older Scouts run orienteering course planned for this campout. Younger Scouts play four games from Games section of the <i>Troop Program Resources</i> .*	
11:00 A.M.	Break camp.	
<b>Special equipment needed</b>	Topographic maps, clipboards, compasses, troop camping equipment	

\**Troop Program Resources for Scout Troops and Varsity Teams*, Supply No. 33588

# COOKING

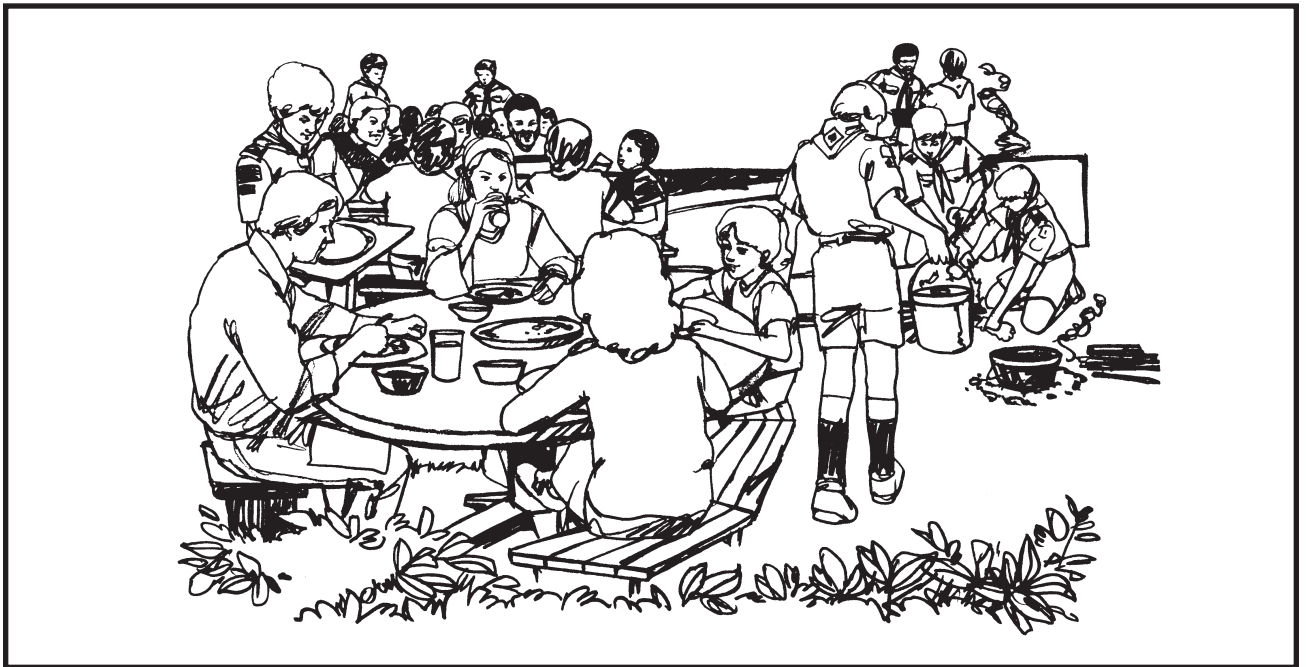

With the possible exception of “It’s time for swimming,” no call in camp is as welcome as “Come and get it!” There is something about the outdoors that adds flavor and zest to the simplest meal. Even the lowly hot dog and hamburger taste better in a camp setting.

This month we will strive to broaden the Scouts’ culinary horizons by showing them how to prepare varied camp meals without spending a lot of time around the cooking fire.

Troop meeting demonstrations and practice will concentrate on the cooking skills that younger Scouts need to learn—menu planning, use of woods tools to prepare fire fuel, fire lays, and cooking. Older Scouts can work on more advanced cooking skills.

The big event will be a patrol feast. Each patrol will be asked to prepare a real feast, well beyond the franks and beans meal, and share it with other patrols. Parents may be invited, too.

The patrol feast could be the climax of a day hike or the centerpiece of a weekend campout. If the patrol leaders’ council decides on a campout, younger Scouts will be able to work on some of the Camping merit badge skills.

## SCOUTING OUTCOMES

This month’s patrol and troop activities should give your Scouts

- An understanding of the importance of a balanced diet for good health

- The skills and knowledge to cook nutritious meals
- Greater confidence in their ability to live comfortably in the outdoors
- Enhanced self-confidence

## ADVANCEMENT OPPORTUNITIES

Depending on the outing or campout, Scouts may complete all or part of the following rank requirements:

### *Tenderfoot*

- Outdoor—cooking, camping, hiking
- Citizenship—flag ceremonies
- Patrol/troop participation—patrol identification
- Personal development—Scout Oath and Law

### *Second Class*

- Outdoor—cooking, camping, hiking
- Citizenship—flag ceremonies
- Patrol/troop participation—leadership
- Personal development—Scout Oath and Law

### *First Class*

- Outdoor—cooking, camping, nature, hiking
- Citizenship—flag ceremonies
- Patrol/troop participation—leadership
- Personal development—Scout Oath and Law



*Merit Badges.* Experienced Scouts can concentrate on the Cooking merit badge this month; they should be able to complete most of the requirements. Depending on the activities during the campout/outing, they may also complete requirements in Backpacking, Camping, Pioneering, Wilderness Survival, and other nature-related merit badges.

### **PARENT/GUARDIAN PARTICIPATION**

The patrol leaders' council may involve parents in the program feature this month by

- Asking qualified parents to assist with instruction in cooking, fire preparation, and making meals
- Inviting them to the patrol feast
- Asking them to provide transportation to the feast

### **PATROL LEADERS' COUNCIL**

The patrol leaders' council should meet during the early part of the previous month to plan troop activities for this program feature. If you do not complete all items on the following agenda, continue planning at patrol leaders' council meetings after each troop meeting.

- Decide whether the patrol feast will be a one-day activity or the highlight of a campout.
- Decide on a site and assign someone to secure permissions, if needed.
- Inventory the troop camping equipment, if you have not done this recently.
- Plan details of troop meetings for the month.

### **FEATURE EVENT**

#### **Patrol Feast**

The patrol feast ought to be just that—a full, tasty meal, including soup or salad, a main course with meat, vegetables, potatoes or other starch, a bread, a dessert, and one or two beverages. Ask the patrols to use raw, dried, or freeze-dried ingredients whenever possible, not canned goods or prepared foods. (Mixes may be used for bread, if desired.)

The aim is to test the Scouts' cooking skills. Urge the patrols to try new recipes and make their meals nutritious and tasty. Many good recipes can be found in the *Cooking* merit badge pamphlet. Others can be found on these pages.

Invite the Scouts' families to join in the feast. Each patrol might plan to feed only its Scouts and their families, or the patrol leaders' council might decide to have patrol dishes placed on a table and served buffet-style to all comers.

### **Fires**

If wood fires are permitted at your site, use wood. Wood should be used, if possible, for basic cooking requirements. Build fires only in existing fire rings, and use small wood gathered from the ground. If there are no designated fire sites, replace sod or ground cover. For more information on Leave No Trace fires, see the *Boy Scout Handbook* and the *Camping* merit badge pamphlet.

### **Campout Activities**

If the patrol feast is the highlight of a weekend campout, the patrol leaders' council must plan other activities. One of these could be fishing, if there is a stream or lake nearby. Successful fishermen could practice cooking fish for one of the big meals of the campout.

The patrol leaders' council might also schedule activities and contests involving various outdoor skills, especially those in which the troop is weak.

### **MAIN COURSES**

#### **One-Potters**

Make the following base and you can vary it by adding ingredients to make eight different dishes. Each recipe serves eight.

**The Base:** Brown 3 pounds of hamburger. Add two to four chopped onions, one or two chopped green peppers, two cans of tomato soup, and salt and pepper to taste. To this base, add the following:

**For Yum-Yums:** ½ to 1 teaspoon of chili powder. Serve the mixture on hamburger buns.

**For Spanish Rice:** two small packages of instant rice.

**For Macaroni Beef:** 1 pound of macaroni, cooked separately.

**For Hunter's Stew:** four cans of vegetable soup.

**For Chili:** four No. two cans of red beans and ½ to 1 teaspoon of chili powder.

**For Squaw Corn:** two cans of corn and ½ pound of diced cheese.

**For Hungarian Hot Pot:** four cans of baked beans.



### **Shish-Kebab (In foil)**

Have a clean, thin stick of sweet wood (taste it) for each diner. On each stick, skewer 1-inch cubes of beef or lamb, chunks of onion and tomato, pieces of green pepper, slices of cucumber and bacon. Wrap kebabs in heavy-duty foil and cook on coals for about 14 minutes, turning once.

### **Pigs in a Blanket (In foil)**

For each diner, wrap slices of bacon around a frankfurter and place in a frankfurter roll. Seal in heavy-duty foil, twisting the ends. Bake in coals for about 15 minutes.

### **Meat Loaf in Cabbage Leaves (In foil)**

For eight servings, mix 2 pounds of hamburger, two eggs, 1 teaspoon salt, dash of pepper, an onion chopped fine, and about 1 cup of bread crumbs. Mix thoroughly and mold into eight portions.

Cut four 1-foot squares of heavy-duty foil. On each square, place a large cabbage leaf. On top of the leaf, put one meat loaf portion, then a slice of American or Cheddar cheese. Sprinkle a little onion soup mixture on the cheese, then top it with a second meat portion. Close the cabbage leaf over the meat and wrap and seal in the foil. Cook in coals for 15 to 20 minutes.

### **Stir-Fry Vegetables with Meat**

Here is a Chinese recipe for advanced camp cooks. It requires a very hot fire and careful timing.

4 tablespoons peanut oil  
2 tablespoons cornstarch mixed with 2 tablespoons water  
1 cup chicken broth  
1 teaspoon sugar  
2 tablespoons soy sauce  
2 cups chopped, *cooked* meat (chicken, beef, or ham)  
6 cups of chopped vegetables from either or both of the groups below:



**Group A:** thinly sliced onions, diced green peppers, celery sliced diagonally in ½ -inch slices.

**Group B:** bean sprouts, shredded Chinese cabbage, sliced mushrooms, sliced bamboo shoots, sliced water chestnuts.

All ingredients must be ready before cooking starts because there is no time to stop once cooking begins.

Place a frying pan over high heat until a drop of water sizzles on it. Add the peanut oil and let it bubble.

Then add vegetables from group A and stir-fry for one minute; make sure vegetables are thoroughly mixed and coated with oil. Then add vegetables from group B and stir-fry one more minute. Add the meat and stir-fry one minute.

Add the soy sauce, sugar, and chicken broth, mixing it well. Now stir the cornstarch paste and add it to the vegetables. Continue cooking until the sauce thickens—about two minutes.

This can be served over noodles or rice (prepared separately).

## **SALADS**

### **Cheese Please Salad**

One large head iceberg lettuce  
Seven hard-boiled eggs  
¾ lb. Swiss cheese, shredded or sliced into thin strips  
1 cup sour cream or plain yogurt  
2 ½ teaspoons dry mustard  
1¼ teaspoons lemon juice  
1¼ teaspoons of poppy, caraway, or dill seeds  
1¼ teaspoons salt  
¼ teaspoon pepper

Slice eggs into quarters, then cut each quarter in half. Set aside. Mix together sour cream, mustard, lemon juice, seeds, salt, and pepper. Add the eggs.

Line a salad bowl with lettuce leaves. Mound the salad in the middle. Sprinkle Swiss cheese on top. If desired, serve with crisp crackers or toast.

### **Potato Salad**

Six medium potatoes  
3 tablespoons chopped parsley  
One finely chopped onion  
1 tablespoon lemon juice  
¾ cup mayonnaise  
1 tablespoon celery seed  
Salt and pepper to taste  
Paprika

Peel the potatoes and cut into small slices. Boil until slightly soft but not mushy. Let potatoes cool.

Add parsley and onion. Mix the lemon juice and mayonnaise together and combine with the potato mixture. Add celery seed, salt, and pepper. Spoon the salad on top of lettuce or spinach leaves. Sprinkle with paprika.

## DESSERTS

### Dump Cake

This recipe requires a Dutch oven.

¼ lb. butter  
18-oz. yellow, spice, or apple cake mix  
1 can of apricot, mincemeat, cherry, or apple pie filling

Use butter to lightly grease the bottom of the Dutch oven. Pour in fruit. Spread the cake mix on top and smooth out. Melt the butter and pour evenly over batter. Add sugar topping if desired.

Put a lid on the Dutch oven and place over coals; also put coals on top of the lid. Bake about 10 minutes, then check to see whether the fruit is bubbling up through the cake mix. When it is, remove the oven from the fire, but leave coals on top until the batter has browned. Slice and serve like brownies.

### Peach Cobbler

This also requires a Dutch oven.

Two No. 2½ cans sliced peaches  
2 cups biscuit mix  
½ cup sugar

Put the Dutch oven on hot coals to preheat it slightly. Pour in peaches, saving some of the juice so the cobbler won't be mushy. Mix the biscuit mix with water and roll dough about a ½-inch thick to fit in the oven. Place the dough over the peaches and sprinkle lightly with sugar.

Put the lid on, place coals on top, and bake until the crust is golden brown.

## ON THE TRAIL

### Nutty Granola

1 cup honey  
¾ cup vegetable oil  
5 cups rolled oats (old fashioned)  
1 cup shredded coconut  
1 cup raw wheat germ  
1 cup dry milk (may be omitted)  
1 cup sesame seeds or shelled sunflower seeds  
1 cup chopped nuts (your choice)  
1 cup raisins (optional)

Warm the honey for easier mixing and stir into vegetable oil. Combine remaining ingredients, except

nuts and raisins. Pour the oil and honey mixture over them and mix well. Spread mixture thinly on three large lightly greased baking sheets. Bake at 275°F for about 35 minutes; stir after first 15 minutes, again after another 10. Add nuts and raisins and finish baking. Stir once or twice while cooling. Cool completely before storing.

One teaspoon of salt may be added to the granola for taste before mixing.

### Trail Food

One box seeded raisins  
One box pitted prunes  
One package dried figs  
1 cup dried apricots  
½ cup chopped lemon peel  
1 cup or more sweet cider

The raisins, prunes, and figs should be ground coarsely and put into a large bowl; then add coarsely chopped apricots and lemon peel. Slowly pour the cider over the fruit until it is workable. Knead, then press mixture into a shallow cake pan lined with wax paper and refrigerate until solid.

When firm, slice into bars and wrap each in wax paper. Store in a cool place.

Dates may be used, but sugar crystals have a tendency to form on them, drying out the bars—the moist consistency of the fruit bar is one of its best features.

### Trail Salad

Outdoors people who love salad are often stuck when trying to assemble the proper ingredients because lettuce and other greens are perishable. Here is a salad made entirely of nourishing ingredients that don't spoil quickly and are easy to transport.

Two cans (17 oz.) peas, drained  
Two eggs, hard-boiled and peeled  
½ medium onion  
One small can pimentos, drained  
1 tbsp. dried parsley flakes  
Salt and pepper to taste  
½ cup mayonnaise

Place drained peas in bowl. Chop eggs, onion, and pimentos, and add with other ingredients to peas. Mix well. Mayonnaise can be added just before serving. (Note: Mayonnaise in a jar once opened is highly perishable without refrigeration. Carry tubes or the smallest jar you can buy.)

Optional additions are finely chopped celery, carrots, radishes, garlic, and sliced mushrooms (fresh or canned). Serves four people.

# COOKING

## TROOP MEETING PLAN

Date \_\_\_\_\_ Week 1

ACTIVITY	DESCRIPTION	RUN BY	TIME
<b>Preopening</b> _____ minutes	Meet outdoors. Have several types of fire lays made and possibly some items cooking in a Dutch oven, or demonstrate cooking without utensils ( <i>Boy Scout Handbook</i> ).		
<b>Opening Ceremony</b> _____ minutes	<ul style="list-style-type: none"> <li>• Form troop into a horseshoe.</li> <li>• Hold uniform inspection.</li> <li>• Repeat the Scout Oath.</li> <li>• Repeat the Pledge of Allegiance.</li> </ul>		
<b>Skills Instruction</b> _____ minutes	<ul style="list-style-type: none"> <li>• New Scouts work on woods tools care and maintenance (<i>Boy Scout Handbook</i>). Review Leave No Trace rules for fires.</li> <li>• Experienced Scouts work on Dutch oven cooking.</li> <li>• Older Scouts work on the Venture program or work with younger Scouts on woods tools instruction.</li> </ul>		
<b>Patrol Meetings</b> _____ minutes	Discuss plans for the outing this month and make sure everyone knows what they will need to bring and what their assignments are for the feast. The new-Scout patrol needs to know what support it will provide for the outing. All other patrols plan activities to work on advancement. Plan the menu for the patrol feast.		
<b>Interpatrol Activity</b> _____ minutes	Play Tug-of-War. (See the Games section of the <i>Troop Program Resources</i> .)		
<b>Closing</b> _____ minutes Total 90 minutes of meeting	<ul style="list-style-type: none"> <li>• Form troop into patrols, call patrol leaders forward to give patrol yells.</li> <li>• Repeat the Scout Law.</li> <li>• Scoutmaster's Minute.</li> <li>• Retire colors.</li> </ul>	SM	
<b>After the Meeting</b>	Patrol leaders' council reviews the next meeting and plans for the troop outing. Begin work on next month's program feature.		

\*Troop Program Resources for Scout Troops and Varsity Teams, Supply No. 33588

# COOKING

## TROOP MEETING PLAN

Date \_\_\_\_\_ Week 2

ACTIVITY	DESCRIPTION	RUN BY	TIME
<b>Preopening</b> _____ minutes			
<b>Opening Ceremony</b> _____ minutes			
<b>Skills Instruction</b> _____ minutes	<ul style="list-style-type: none"> <li>• New Scouts learn which woods make the best fires and how to lay a fire using two different methods (<i>Boy Scout Handbook</i>).</li> <li>• Experienced Scouts work on cooking with Peak stoves (if available), repair and maintenance, and safe handling of fuel. Or, work on procedures to dehydrate food.</li> <li>• Older Scouts work on the Venture program or serve as instructors for the other sessions, or prepare necessary items for merit badge work that could be done on the outing.</li> </ul>		
<b>Patrol Meetings</b> _____ minutes	Review assignments for the feast. The new Scouts continue learning the basics of cooking. Finalize the menu and set a time to practice making the meal that you will prepare for the feast.		
<b>Interpatrol Activity</b> _____ minutes	Do Fuzz-Stick Relay. (See the Games section of the <i>Troop Program Resources</i> .* )		
<b>Closing</b> _____ minutes Total 90 minutes of meeting	<ul style="list-style-type: none"> <li>• Scoutmaster's Minute.</li> <li>• Retire colors.</li> </ul>	SM	
<b>After the Meeting</b>	Patrol leaders' council reviews the next meeting and plans for the outing. Continue work on next month's program feature.		

\*Troop Program Resources for Scout Troops and Varsity Teams, Supply No. 33588

# COOKING

## TROOP MEETING PLAN

Date \_\_\_\_\_ Week 3

ACTIVITY	DESCRIPTION	RUN BY	TIME
<b>Preopening</b> _____ minutes			
<b>Opening Ceremony</b> _____ minutes			
<b>Skills Instruction</b> _____ minutes	<ul style="list-style-type: none"> <li>• New Scouts work on preparing a simple dish. This should be done with either a personal cook kit or patrol/troop cooking equipment.</li> <li>• Experienced Scouts work on identifying wild edible plants and how to prepare them.</li> <li>• Older Scouts work on the Venture program or utensilless cooking techniques, or plan games and competitions.</li> </ul>		
<b>Patrol Meetings</b> _____ minutes	Finalize the menu for the outing this month and make sure everyone knows what he will need to bring. Review clothing and equipment needs and collect any necessary fees. Announce the route for parents who will come and join the feast.		
<b>Interpatrol Activity</b> _____ minutes	Play British Bulldog. (See the Games section of the <i>Troop Program Resources</i> .* )		
<b>Closing</b> _____ minutes  Total 90 minutes of meeting	<ul style="list-style-type: none"> <li>• Scoutmaster's Minute.</li> <li>• Retire colors.</li> </ul>	SM	
<b>After the Meeting</b>	Patrol leaders' council reviews the next meeting and plans for the troop outing. Continue work on next month's program feature.		

\*Troop Program Resources for Scout Troops and Varsity Teams, Supply No. 33588

# COOKING

## TROOP MEETING PLAN

Date \_\_\_\_\_ Week 4

ACTIVITY	DESCRIPTION	RUN BY	TIME
<b>Preopening</b> _____ minutes			
<b>Opening Ceremony</b> _____ minutes			
<b>Skills Instruction</b> _____ minutes	<ul style="list-style-type: none"> <li>• New Scouts work on cooking techniques and camp sanitation procedures, review Leave No Trace methods (<i>Boy Scout Handbook</i>).</li> <li>• Experienced Scouts finalize the details for the games and competitions for the outing and make sure that any required equipment is gathered.</li> <li>• Older Scouts work on the Venture program or assist in the game preparation.</li> </ul>		
<b>Patrol Meetings</b> _____ minutes	Review plans and assignments for the feast. Make sure everyone knows travel plans and equipment needs. Review the patrol duty roster. Practice interpatrol activities that will take place.		
<b>Interpatrol Activity</b> _____ minutes	Play Swat 'Em. (See the Games section of the <i>Troop Program Resources</i> .)		
<b>Closing</b> _____ minutes Total 90 minutes of meeting	<ul style="list-style-type: none"> <li>• Scoutmaster's Minute—reflection on the experiences of the month.</li> <li>• Retire colors.</li> </ul>	SM	
<b>After the Meeting</b>	Patrol leaders' council reviews the next meeting and checks any last-minute details for the troop campout or outing. Finalize work on next month's program feature.		

\*Troop Program Resources for Scout Troops and Varsity Teams, Supply No. 33588

# COOKING

## TROOP OUTDOOR PROGRAM PLAN

Date \_\_\_\_\_

TIME	ACTIVITY	RUN BY
<b>Friday evening</b>	Load gear at meeting location, leave for campsite. Plan only a light meal en route.	SPL
	Arrive at campsite; off-load equipment. Set up patrol sites. Stow gear and set up camp.	SPL
<b>Saturday</b> 6:30 A.M.	Cooks and assistants up. Prepare breakfast. (These Scouts should be working on First and Second Class requirements.)	Cooks, assistants
7:00 A.M.	Everyone else up. Take care of personal hygiene, air tents, hang out sleeping bags.	
7:30 A.M.	Breakfast	
8:00 A.M.	Clean up.	Cooks
	Patrols put up the gear for morning activities, clean up patrol site.	
8:30–10:30 A.M.	Patrol games—use four games from the Games section of the <i>Troop Program Resources</i> .*	SPL
10:30 A.M.	Special patrol activities; could include fishing, if available. Work on advancement such as lashings, map and compass, physical fitness.	
11:30 A.M.	Cooks and assistant cooks return to site to prepare lunch.	Cooks, assistants
Noon	Lunch	
12:30 P.M.	Clean up.	
1 P.M.	Begin preparation for special patrol feast: <ul style="list-style-type: none"> <li>• Tenderfoot—prepare fire lays</li> <li>• Second Class—assist in food preparation, clean up</li> <li>• First Class—prepare meals, supervise cleanup</li> </ul>	
4 P.M.	Prepare campfire for evening; gather tables in central location and set up.	
4:30 P.M.	Parents and guests begin to arrive; have entertainment prepared for parents.	Cooks
4:45 P.M.	Bring food to central location, set up buffet.	
5:00 P.M.	Feast	SPL
6:30 P.M.	Clean up.	Cooks
7:30 P.M.	Campfire	

\*Troop Program Resources for Scout Troops and Varsity Teams, Supply No. 33588

<b>TIME</b>	<b>ACTIVITY</b>	<b>RUN BY</b>
8:30 P.M.	Parents return home.	
9:30 P.M.	Cracker barrel	
10:00 P.M.	Lights out	
<b>Sunday</b> 6:30 A.M.	Cooks and assistants up. Prepare breakfast. (These Scouts should be working on First and Second Class requirements.)	Cooks assistants
7:00 A.M.	Everyone else up. Take care of personal hygiene, air tents, hang out sleeping bags.	
7:30 A.M.	Breakfast	
8:00 A.M.	Clean up.	Cooks
	Patrols put up the gear for morning activities, clean up patrol site.	
8:30 A.M.	Worship service	
9:00–11:00 A.M.	Patrol games—use four games from the Games section of the <i>Troop Program Resources</i> .*	
11:00 A.M.	Break camp.	
<b>Special equipment needed</b>	Dutch ovens, dining flies, charcoal starters, troop camping equipment, eating utensils for parents	

\**Troop Program Resources for Scout Troops and Varsity Teams*, Supply No. 33588



## CULTURAL AWARENESS

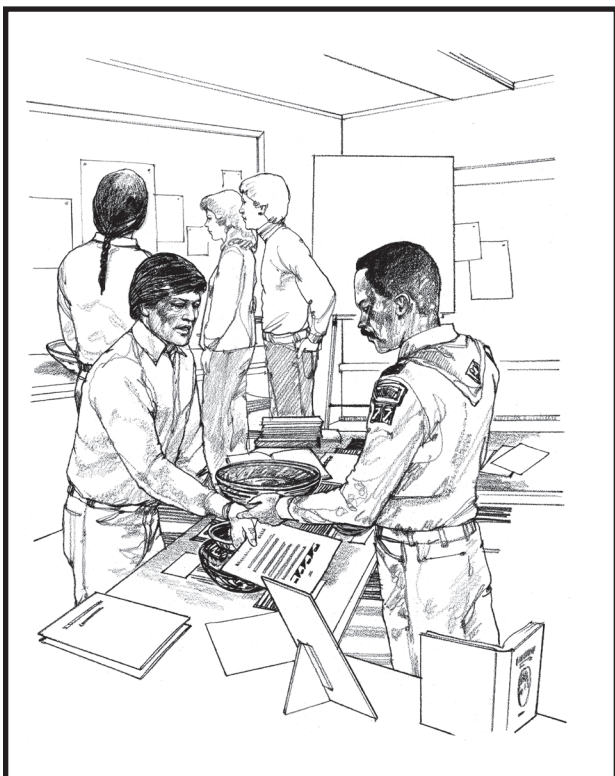

The history of every community in the United States has been influenced by many different groups: the native American Indians who lived here first, the various peoples who have immigrated to this country over the past 500 years, and those who continue to come to this country today. Each nationality brings its own language and customs. Initially these peoples settled near their friends and family, forming neighborhoods with a predominant single-ethnic heritage.

By the time the Scouts in the troop reach midlife, most communities will no longer have a predominant single ethnic heritage, and many communities in the United States will reflect the cultural diversity of the world. This month's program feature will help Scouts to better understand the different ethnic groups represented in their communities.

The troop's big event this month will be either a cultural fair or a cultural awareness campout. These activities might be part of a daylong event or tied into an overnight campout.

### SCOUTING OUTCOMES

This month's patrol and troop activities should give your Scouts

- A greater understanding of their community and its people

- A sensitivity to people of other ethnic backgrounds
- A better understanding of their duty to help other people
- Awareness of their rights and duties as citizens

### ADVANCEMENT OPPORTUNITIES

By month's end, all Scouts should have met many of their citizenship requirements through First Class. Depending on the activities, they may also complete all or part of the following rank requirements:

#### *Tenderfoot*

- Outdoor—hiking, camping
- Citizenship—flag ceremonies, Good Turn
- Patrol/troop participation—patrol identification
- Personal development—Scout Oath and Law

#### *Second Class*

- Outdoor—cooking, camping, hiking
- Citizenship—flag ceremonies, Good Turn
- Patrol/troop participation—leadership
- Personal Development—Scout Oath and Law

#### *First Class*

- Outdoor—cooking, camping, nature, hiking
- Citizenship—flag ceremonies, Good Turn
- Patrol/troop participation—leadership
- Personal Development—Scout Oath and Law

*Merit Badges.* Older Scouts may concentrate on the Citizenship in the World merit badge this month; they should be able to complete many of the requirements. Depending on activities during the month, they may also complete requirements in Citizenship in the Community, Citizenship in the Nation, Indian Lore, and Genealogy merit badges.

### PARENT/GUARDIAN PARTICIPATION

The patrol leader's council may involve parents in the program feature this month by

- Asking parents of different ethnic backgrounds to come talk about their culture or assist with the cultural fair
- Inviting parents on the outing
- Asking parents to provide transportation for the outing

## **PATROL LEADERS' COUNCIL**

The patrol leaders' council should meet during the early part of the previous month to plan troop activities for this program feature. If you don't complete all items on the following agenda, continue planning at patrol leaders' council meetings after each troop meeting.

- If the event is a cultural fair or a cultural awareness campout, will the event be held for the public or will it be just for the troop? Will it be part of an outing or a daylong event?
- If the event is a cultural fair, discuss what ethnic groups are represented in the community and should be invited to attend. Scouts of those ethnic backgrounds should be put in charge of that group.

## **FEATURE EVENTS**

### **The Cultural Fair**

The purpose of the cultural fair is to make Scouts more aware of the many people who make up this great country. Identify each ethnic group in your community and invite each group to participate in your fair. You probably have many of the ethnic groups represented in your troop. Ask each representative to display clothing, food, pictures, and any other items that show the uniqueness of their culture. The fair should be educational, but it also can be fun! You may want to invite Scout families to the fair and consider making it open to the community.

### **A Cultural Awareness Campout**

If you choose cultural awareness as a monthly program feature, you will want to emphasize that a person's ethnic background is something to be proud of, and that Scouts should be careful not to make fun of another culture by making disparaging remarks or singling out a person because of his or her ethnic background. Some of your Scouts may not know their ethnic background. If so, they should be encouraged to discuss this with a family member and try to learn more about their family's history. This program feature might even lead Scouts to learn more about the genealogy of their family. If so, challenge them to consider earning the Genealogy merit badge.

The area of the country that you live in may affect the choice of ethnic group you choose to highlight, as you may want to plan a campout in an area that was native to your choice. Study the resources of your area and decide what is available within a hundred miles of your home. Our country has many ruins that have been preserved in national and state parks. Here are a few suggestions.

- American Indian tribes lived in virtually every area of the United States. You might want to select a specific tribe, study its background, and learn about its culture. Some tribes were farmers, others were hunters. Some lived in adobe huts, others in teepees. Their dress varied according to the climate in which they lived and the resources that were available to them. On the campout, you may want to construct a structure similar to what that tribe lived in. Plan a menu of what they likely ate, play the games they played, and make clothing similar to what they wore. The Indian Lore merit badge might be a natural for some Scouts to begin working on.
- The Hispanic culture is one that your Scouts might find interesting. Plan your campout around meals of Hispanic origin, and work on learning some basic Spanish words. Invite a Hispanic person to tell about his or her colorful culture. Soccer is the sport of many Hispanics, and you might choose to have a soccer tournament among your patrols.
- The African American culture would be an interesting historical study for a troop. Invite an African American person to tell about life in Africa, how his or her ancestors were brought to America as slaves, and how they were liberated. Identify famous African Americans, and show how they have influenced American music, food, sports, and literature.
- If you choose to study the Asian culture, ask a person of Asian origin to tell the troop about his or her ancestors' immigration to America. Many Asians chose to come to America in the mid-1800s to help build the transcontinental railroad.

Your choice is not limited to the cultures above; they may be any that your Scouts are interested in, including all nationalities and religious groups. Focus on what makes each group unique and special to its members.

Leading up to the campout, you might choose to do a special event at each troop meeting. A few suggestions might include:

- A food demonstration in preparation for the campout
- A guest speaker to tell about his or her culture
- A demonstration of the favorite sport of your country of choice
- A study of famous people from the country of choice

# CULTURAL AWARENESS

## TROOP MEETING PLAN

Date \_\_\_\_\_ Week 1

ACTIVITY	DESCRIPTION	RUN BY	TIME
<b>Preopening</b> _____ minutes	Play Bell Tag. (See the Games section of the <i>Troop Program Resources</i> . *)		
<b>Opening Ceremony</b> _____ minutes	<ul style="list-style-type: none"> <li>• Form troop into parallel patrols.</li> <li>• Present colors.</li> <li>• Sing the National Anthem.</li> </ul>		
<b>Skills Instruction</b> _____ minutes	<ul style="list-style-type: none"> <li>• New Scouts work on raising, lowering, and folding the U.S. flag. Plan and rehearse an opening ceremony to use at the next meeting. Play Overtake. (See the Games section of the <i>Troop Program Resources</i>. *)</li> <li>• Experienced Scouts visit a meeting of a local ethnic group.</li> <li>• Older Scouts work on the Venture program.</li> </ul>		
<b>Patrol Meetings</b> _____ minutes	Identify Scouts in the patrol who need to participate in flag ceremonies and Good Turn projects. Suggest activities that these Scouts can participate in to fulfill rank requirements.		
<b>Interpatrol Activity</b> _____ minutes	Play Submarines and Minefields. (See the Games section of the <i>Troop Program Resources</i> . *)		
<b>Closing</b> _____ minutes Total 90 minutes of meeting	<ul style="list-style-type: none"> <li>• Scoutmaster's Minute—consider one that addresses people of different ethnic backgrounds.</li> <li>• Form troop into patrols and sing "God Bless America."</li> <li>• Retire colors.</li> </ul>	SM	
<b>After the Meeting</b>	Patrol leaders' council reviews the next meeting and plans for troop outing. Begin work on next month's program feature.		

\*Troop Program Resources for Scout Troops and Varsity Teams, Supply No. 33588

# CULTURAL AWARENESS

## TROOP MEETING PLAN

Date \_\_\_\_\_ Week 2

ACTIVITY	DESCRIPTION	RUN BY	TIME
<b>Preopening</b> _____ minutes	Play Sleeping Pirate. (See the Games section of the <i>Troop Program Resources</i> .)		
<b>Opening Ceremony</b> _____ minutes	<ul style="list-style-type: none"> <li>• Form troop into parallel patrols.</li> <li>• Present colors.</li> <li>• Sing the national anthem.</li> </ul>		
<b>Skills Instruction</b> _____ minutes	<ul style="list-style-type: none"> <li>• New Scouts work on the Heimlich maneuver.</li> <li>• Experienced Scouts begin planning cultural fair by determining ethnic groups to be involved and selecting Scouts to help.</li> <li>• Older Scouts work on the Venture program.</li> </ul>		
<b>Patrol Meetings</b> _____ minutes	Review plans and assignments for the cultural fair.		
<b>Interpatrol Activity</b> _____ minutes	Play Night Eyes. (See the Games section of the <i>Troop Program Resources</i> .)		
<b>Closing</b> _____ minutes Total 90 minutes of meeting	<ul style="list-style-type: none"> <li>• Scoutmaster's Minute.</li> <li>• Retire colors.</li> </ul>	SM	
<b>After the Meeting</b>	Patrol leaders' council reviews the next meeting and plans for troop campout or outing. Continue work on next month's program feature.		

\*Troop Program Resources for Scout Troops and Varsity Teams, Supply No. 33588

# CULTURAL AWARENESS

## TROOP MEETING PLAN

Date \_\_\_\_\_ Week 3

ACTIVITY	DESCRIPTION	RUN BY	TIME
<b>Preopening</b> _____ minutes			
<b>Opening Ceremony</b> _____ minutes			
<b>Skills Instruction</b> _____ minutes	<ul style="list-style-type: none"> <li>• New Scouts prepare a personal first-aid kit.</li> <li>• Experienced Scouts continue planning details for cultural fair.</li> <li>• Older Scouts work on the Venture program.</li> </ul>		
<b>Patrol Meetings</b> _____ minutes			
<b>Interpatrol Activity</b> _____ minutes	Have a blindfolded tent-pitching contest.		
<b>Closing</b> _____ minutes Total 90 minutes of meeting	<ul style="list-style-type: none"> <li>• Scoutmaster's Minute.</li> <li>• Retire colors.</li> </ul>	SM	
<b>After the Meeting</b>	Patrol leaders' council reviews the next meeting. Continue work on next month's program feature.		

# CULTURAL AWARENESS

## TROOP MEETING PLAN

Date \_\_\_\_\_ Week 4

ACTIVITY	DESCRIPTION	RUN BY	TIME
<b>Preopening</b> _____ minutes			
<b>Opening Ceremony</b> _____ minutes			
<b>Skills Instruction</b> _____ minutes			
<b>Patrol Meetings</b> _____ minutes			
<b>Interpatrol Activity</b> _____ minutes	Do Knot-Tying Relay, wearing gloves or mittens. (See the Games section of the <i>Troop Program Resources</i> .* )		
<b>Closing</b> _____ minutes Total 90 minutes of meeting	<ul style="list-style-type: none"> <li>• Scoutmaster's Minute—reflection on the experiences of the month.</li> <li>• Retire colors.</li> </ul>	SM	
<b>After the Meeting</b>	Patrol leaders' council reviews the next meeting and last-minute details for the troop outing or activity. Finalize work on next month's program feature.		

\*Troop Program Resources for Scout Troops and Varsity Teams, Supply No. 33588

## CULTURAL AWARENESS TROOP OUTDOOR PROGRAM PLAN

Date \_\_\_\_\_

TIME	ACTIVITY	RUN BY
<b>Friday evening</b>	Load gear at meeting location, leave for campsite. Plan only a light meal en route.	SPL
	Arrive at campsite; off-load equipment. Set up patrol sites. Stow gear and set up camp.	SPL
<b>Saturday</b> 6:30 A.M.	Cooks and assistants up. Prepare breakfast. (Cooks should be working on First and Second Class requirements.)	Cooks, assistants
7:00 A.M.	Everyone else up. Take care of personal hygiene, air tents, hang out sleeping bags.	
7:30 A.M.	Breakfast	
8:00 A.M.	Clean up.	
	Patrols put up the gear for morning activities, clean up patrol site.	
9:00–11:00 A.M.	Cultural awareness activities	
11:00 A.M.	Cooks prepare lunch.	Cooks
Noon	Lunch	
1 P.M.	Continue cultural awareness activities.	
4 P.M.	Start dinner preparations.	Cooks
5:00 P.M.	Dinner	
6:00 P.M.	Clean up.	Cooks
8:00 P.M.	Campfire	
9:00 P.M.	Cracker barrel	
10:00 P.M.	Lights out	
<b>Sunday</b> 6:30 A.M.	Cooks and assistants up. Prepare breakfast. (Cooks should be working on First and Second Class requirements.)	Cooks, assistants
7:00 A.M.	Everyone else up. Take care of personal hygiene, air tents, hang out sleeping bags.	
7:30 A.M.	Breakfast	
8:00 A.M.	Clean up.	Cooks
	Patrols put up gear for morning activities, clean up patrol site.	

TIME	ACTIVITY	RUN BY
8:30 A.M.	Worship service	
9:00–11:00 A.M.	Patrol games—use four games from the Games section of the <i>Troop Program Resources</i> .*	
11:00 A.M.	Break camp.	
<b>Special equipment needed</b>	Materials for cultural awareness activities	

\**Troop Program Resources for Scout Troops and Varsity Teams*, No. 33588



# EMERGENCY PREPAREDNESS



Our Scout motto, “Be Prepared,” is never more important than in dealing with emergency situations. The ability to make correct decisions under pressure really tests a Scout. As Scouts progress through the program, they perfect their skills in leadership, the outdoors, and working with people. Emergency preparedness means being prepared in all of these areas.

Your troop meeting activities this month should focus on emergency preparedness procedures. Younger Scouts will work on first aid requirements for Tenderfoot through First Class. Experienced Scouts will concentrate on advanced skills and the First Aid and Emergency Preparedness merit badges.

The big event will be “The Real Thing” weekend. Patrols will face some realistic emergency situations requiring first aid, decision making, and teamwork.

## SCOUTING OUTCOMES

This month’s patrol and troop activities should give your Scouts

- An understanding of basic first-aid techniques
- A good grasp of the fundamentals for dealing with life-threatening situations
- Enhanced self-confidence in making decisions

## ADVANCEMENT OPPORTUNITIES

Depending on the length of your outing, Scouts may complete all or part of the following rank requirements:

### *Tenderfoot*

- Outdoor—cooking, camping, hiking
- Citizenship—flag ceremonies, first aid
- Patrol/troop participation—patrol identification
- Personal development—Scout Oath and Law

### *Second Class*

- Outdoor—cooking, camping, hiking
- Citizenship—flag ceremonies, first aid

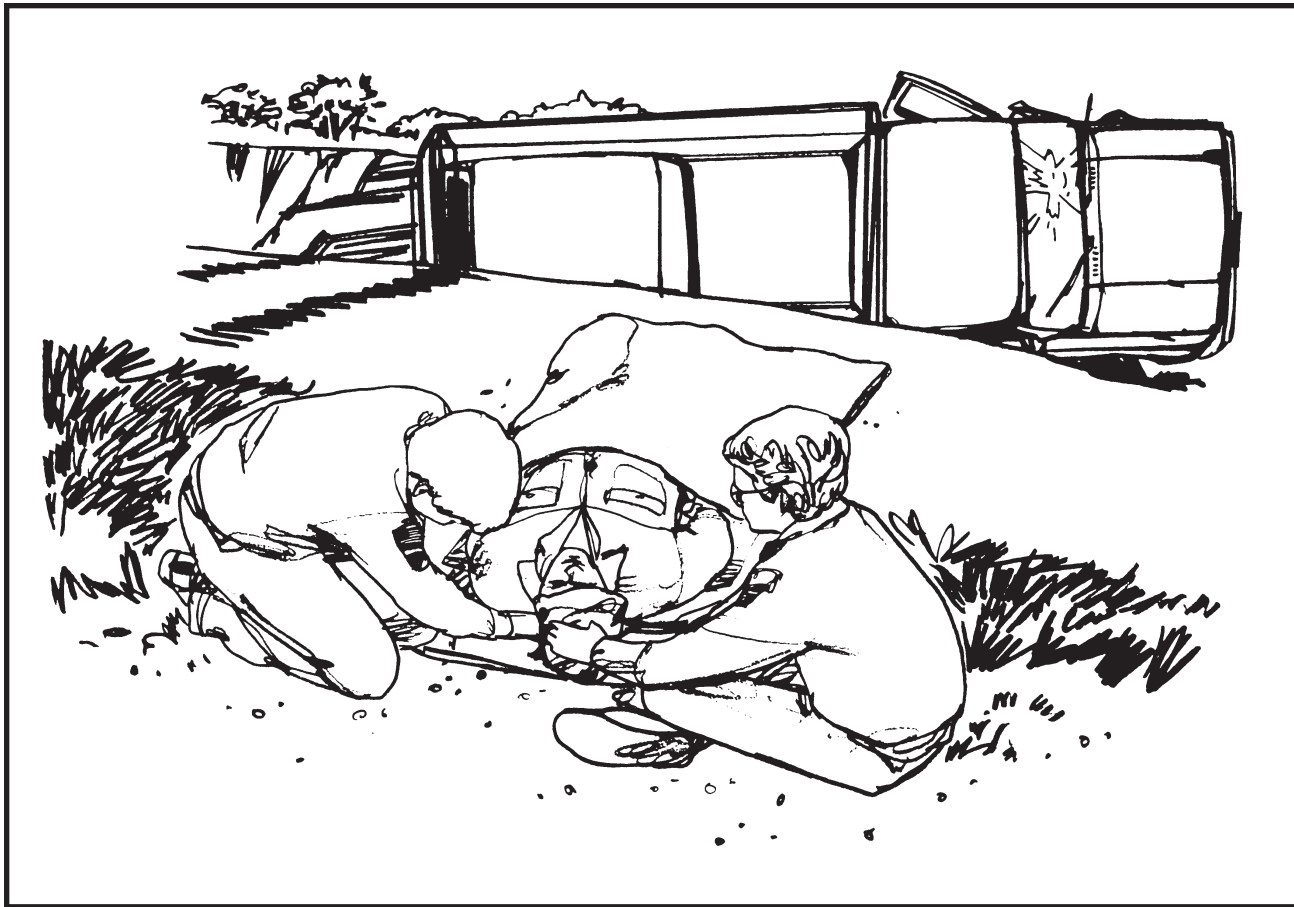

- Patrol/troop participation—patrol identification
- Personal development—Scout Oath and Law

*First Class*

- Outdoor—cooking, camping, nature, hiking
- Citizenship—flag ceremonies, Good Turn
- Patrol/troop participation—patrol identification
- Personal development—Scout Oath and Law

*Merit Badges.* Older Scouts can concentrate on the Emergency Preparedness and First Aid merit badges this month. Depending on activities during the outing, they may also complete requirements in Camping, Cooking, Hiking, Lifesaving, and other outdoor-related merit badges.

**PARENT/GUARDIAN PARTICIPATION**

The patrol leaders' council can involve parents in the program feature this month by

- Asking qualified parents to assist with first aid instruction
- Inviting parents to "The Real Thing" event

- Asking parents to provide transportation to the site of the outing

**PATROL LEADERS' COUNCIL**

The patrol leaders' council should meet during the early part of the previous month to plan troop activities for this program feature. If you don't complete all items on the following agenda, continue planning at patrol leaders' council meetings after each troop meeting.

- Decide whether "The Real Thing" will be a single day or a weekend campout.
- Choose the site and secure permission, if needed.
- Ask the patrol leaders to inventory their patrol's first-aid supplies and report deficiencies. Fill needs. Ask for help from the troop committee.
- Either plan the "emergency" situations the patrols will face during "The Real Thing," or, if you want complete surprise, assign an adult leader to plan them. See sample emergencies later in this section.
- Plan details of troop meetings for the month. Assign patrol demonstrations, covering skills that will be needed for "The Real Thing."



- Arrange to invite the Emergency Preparedness and First Aid merit badge counselors to help with troop meeting instruction and to serve as judges for patrol performance for the big event.

## FEATURE EVENT

### The Real Thing

The big event will be a practice exercise to test your patrols' reactions to emergencies. Set up emergency situations that will be within the skill levels of the Scouts. At least some of the situations should require making decisions in "life-threatening" emergencies.

Some of the sample emergencies take place in wilderness situations; others are in urban areas. Family members or friends may play the parts of victims.

Have Emergency Preparedness or First Aid merit badge counselors or other experts on hand to judge patrol performances.

The following are some sample problems. Make up additional problems that will involve Scouts of various skill levels.

**PROBLEM 1.** A Scout patrol is on a campout in a heavily wooded area of a national forest. A severe thunderstorm and flash flood hits the campsite. Both adult leaders are immobilized with broken legs; one is unconscious. Several Scouts have severe cuts. The nearest ranger station is five miles from their campsite. The patrol has managed to radio you on its two-way radio to request help. You are half a mile away in the base campsite. What do you do?

**(Possible action:** Instruct the patrol members by radio to treat their most seriously injured persons first and get all patrol members to a safe place above the flood. You send for help at the ranger station, or try to reach the station by radio. Then assemble needed gear and set out to help the patrol.)

**PROBLEM 2.** Your patrol is hiking on a country road. A passing farm truck goes out of control and hits two patrol members. The truck then veers off the road and turns over in a ditch; the driver is knocked unconscious. You notice what appears to be toxic chemicals leaking from a container in the truck into the ditch. The nearest farmhouse is 1½ miles away. What do you do?

**(Possible action:** Send two Scouts running to the farmhouse to call for medical help and to inform the police about the accident; tell the police about the spilled material. Treat the most seriously injured victims first. The driver may have suffered serious neck or spinal injuries; to avoid aggravating them, do not move him unless necessary (as in the case of a fire).)

**PROBLEM 3.** Your patrol is passing a playground when one of the pieces of playground equipment collapses. Several of the children suffer broken bones and severe cuts. Many of the other children panic and begin running out in the street. What do you do?

**(Possible action:** Get control of the situation; don't panic. Calm the children and keep them seated. Reassure them that they will be OK. Send two Scouts for help, and treat the most severe cases first.)

**PROBLEM 4.** Your patrol is in a shopping mall. A tornado passes by, hitting one end of the mall and knocking out power. Several people are injured by flying debris, the phone system is out, and you are half a mile from a fire station. How do you react?

**(Possible action:** Keep calm. Assess potential hazards such as live wires, glass, and unstable structures. Move the injured to a safe place. Send two Scouts to the fire station for help.)

# EMERGENCY PREPAREDNESS

## TROOP MEETING PLAN

Date \_\_\_\_\_ Week 1

ACTIVITY	DESCRIPTION	RUN BY	TIME
<b>Preopening</b> _____ minutes	Have Scouts demonstrate techniques necessary in getting out of a building that is on fire. Practice hurry cases for first aid ( <i>Boy Scout Handbook</i> ).		
<b>Opening Ceremony</b> _____ minutes	<ul style="list-style-type: none"> <li>• Form troop into a “square U.”</li> <li>• Hold uniform inspection.</li> <li>• Present colors.</li> <li>• Recite the words to the national anthem.</li> </ul>		
<b>Skills Instruction</b> _____ minutes	<ul style="list-style-type: none"> <li>• New Scouts work on first aid for minor burns or scalds, blisters, venomous snakebite, transporting an injured person.</li> <li>• Experienced Scouts work on troop mobilization techniques and moving people in emergency situations.</li> <li>• Older Scouts work on the Venture program or help the troop guide teach basic first aid to new Scouts.</li> </ul>		
<b>Patrol Meetings</b> _____ minutes	Discuss plans for “The Real Thing” drill this month and make sure everyone knows their assignments. Each patrol should start practicing the problems they will be facing during the drill. Plan to work on skills for related merit badges. Have new Scouts also work on requirements for flag ceremonies and service projects.		
<b>Interpatrol Activity</b> _____ minutes	Play Scouts to the Rescue. (See the Games section of the <i>Troop Program Resources</i> .* )		
<b>Closing</b> _____ minutes Total 90 minutes of meeting	<ul style="list-style-type: none"> <li>• Have a Scout define what “helpful” means.</li> <li>• Scoutmaster’s Minute.</li> <li>• Retire colors.</li> </ul>	SM	
<b>After the Meeting</b>	Patrol leaders’ council reviews the next meeting and troop outing. Begin work on next month’s program feature.		

\*Troop Program Resources for Scout Troops and Varsity Teams, Supply No. 33588

# EMERGENCY PREPAREDNESS

## TROOP MEETING PLAN

Date \_\_\_\_\_ Week 2

ACTIVITY	DESCRIPTION	RUN BY	TIME
<b>Preopening</b> _____ minutes			
<b>Opening Ceremony</b> _____ minutes			
<b>Skills Instruction</b> _____ minutes	<ul style="list-style-type: none"> <li>• New Scouts practice first aid for rabid animal bite, puncture wounds, serious burns, heat exhaustion. Do Arm Sling Relay. (See the Games section of the <i>Troop Program Resources</i>. *)</li> <li>• Experienced Scouts work on lost person techniques (<i>Emergency Preparedness</i> merit badge pamphlet).</li> <li>• Older Scouts work on the Venture program or work with younger Scouts on first-aid basics.</li> </ul>		
<b>Patrol Meetings</b> _____ minutes	Review assignments for “The Real Thing” drill. Practice interpatrol activities.		
<b>Interpatrol Activity</b> _____ minutes	Do Stretcher Relay. (See the Games section of the <i>Troop Program Resources</i> . *)		
<b>Closing</b> _____ minutes  Total 90 minutes of meeting	<ul style="list-style-type: none"> <li>• Scoutmaster’s Minute.</li> <li>• Retire colors.</li> </ul>	SM	
<b>After the Meeting</b>	Patrol leaders’ council reviews the next meeting and “The Real Thing” drill. Continue work on next month’s program feature.		

\*Troop Program Resources for Scout Troops and Varsity Teams, Supply No. 33588

# EMERGENCY PREPAREDNESS

## TROOP MEETING PLAN

Date \_\_\_\_\_ Week 3

ACTIVITY	DESCRIPTION	RUN BY	TIME
<b>Preopening</b> _____ minutes			
<b>Opening Ceremony</b> _____ minutes			
<b>Skills Instruction</b> _____ minutes	<ul style="list-style-type: none"> <li>• New Scouts work on basic first aid bandages for head injuries, upper arm/collarbone, sprained ankle (<i>Boy Scout Handbook</i>).</li> <li>• Experienced Scouts work on boating accident survival techniques.</li> <li>• Older Scouts work on the Venture program or work on first aid with the younger Scouts.</li> </ul>		
<b>Patrol Meetings</b> _____ minutes	Finalize the plans for the drill. Make sure everyone knows the time and location for the event. Practice interpatrol activities.		
<b>Interpatrol Activity</b> _____ minutes	Play Steal-the-Bacon. (See the Games section of the <i>Troop Program Resources</i> .*)		
<b>Closing</b> _____ minutes  Total 90 minutes of meeting	<ul style="list-style-type: none"> <li>• Scoutmaster's Minute.</li> <li>• Retire colors.</li> </ul>	SM	
<b>After the Meeting</b>	Patrol leaders' council reviews the next meeting and "The Real Thing" drill. Continue work on next month's program feature.		

\*Troop Program Resources for Scout Troops and Varsity Teams, Supply No. 33588

# EMERGENCY PREPAREDNESS

## TROOP MEETING PLAN

Date \_\_\_\_\_ Week 4

ACTIVITY	DESCRIPTION	RUN BY	TIME
<b>Preopening</b> _____ minutes			
<b>Opening Ceremony</b> _____ minutes			
<b>Skills Instruction</b> _____ minutes	<ul style="list-style-type: none"> <li>• New Scouts test their skills using the first-aid problems in the Games section of the <i>Troop Program Resources</i>. * Learn the five common signals of a heart attack.</li> <li>• Experienced Scouts work on ice rescue methods and signaling aircraft with body signals and ground-to-air visuals.</li> <li>• Older Scouts work on the Venture program or practice a realistic first-aid makeup for the drill.</li> </ul>		
<b>Patrol Meetings</b> _____ minutes	Make sure everyone has the plans for the drill. Practice any interpatrol activities that will take place.		
<b>Interpatrol Activity</b> _____ minutes	Play Ice Accident. (See the Games section of the <i>Troop Program Resources</i> . *)		
<b>Closing</b> _____ minutes Total 90 minutes of meeting	<ul style="list-style-type: none"> <li>• Scoutmaster's Minute—reflection on the experiences of the month.</li> <li>• Retire colors.</li> </ul>	SM	
<b>After the Meeting</b>	Patrol leaders' council reviews the next meeting and any last-minute details for "The Real Thing." Finalize work on next month's program feature.		

\*Troop Program Resources for Scout Troops and Varsity Teams, Supply No. 33588



# EMERGENCY PREPAREDNESS

## TROOP OUTDOOR PROGRAM PLAN

**Date** \_\_\_\_\_

<b>TIME</b>	<b>ACTIVITY</b>	<b>RUN BY</b>
<b>Saturday</b> 9:00 A.M.	Older Scouts arrive at location for The Real Thing drill and set up necessary materials.	SPL
9:30 A.M.	Rest of troop arrives.	
10:00 A.M.	Begin problem-solving.	SPL
11:30 A.M.	Sack lunch	
12:30 P.M.	Continue problem-solving.	SPL
4:30 P.M.	Present awards, leave for home.	SM
<b>Special equipment needed</b>	First aid supplies for the drill, awards	



# ENGINEERING

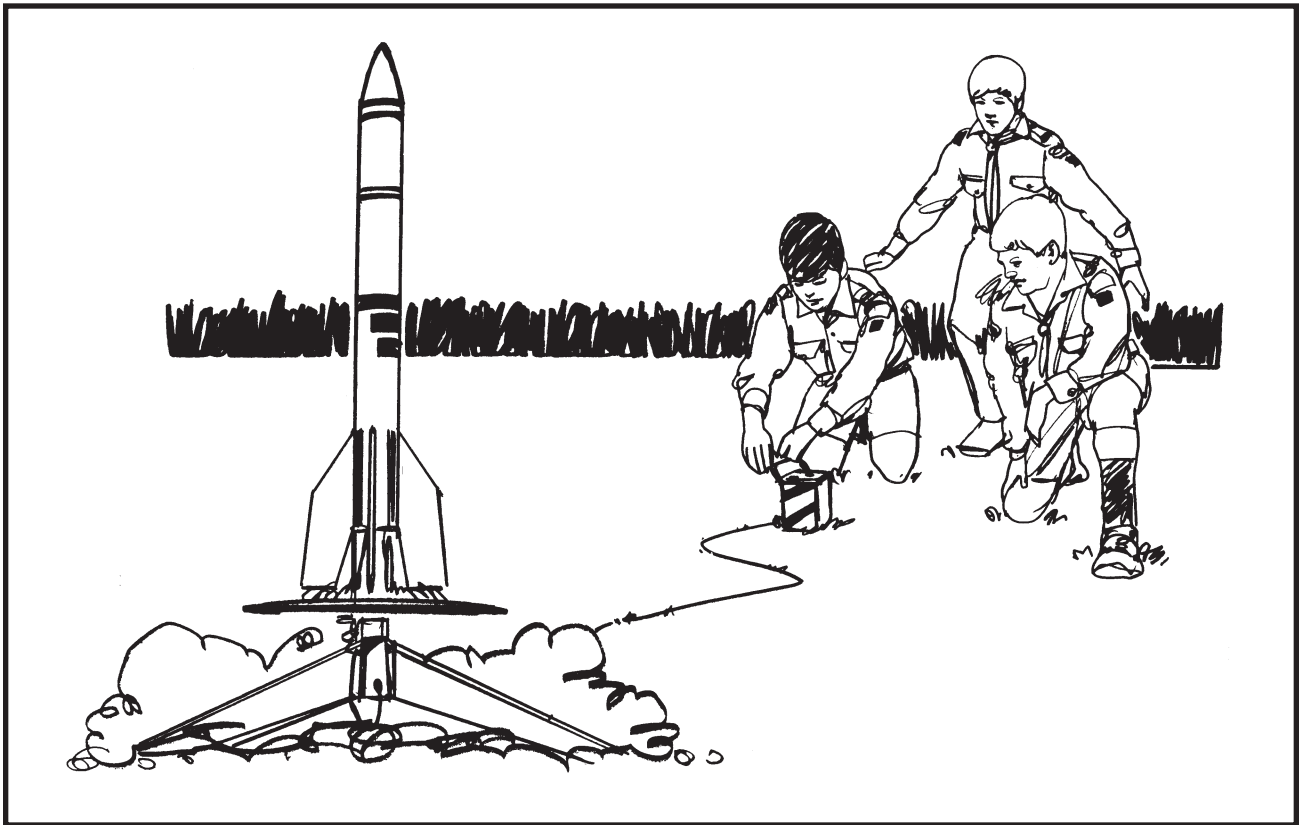

Engineering covers a variety of fields as broad as all outdoors—or indoors, for that matter. Virtually everything we use in the course of a normal day has an engineer's stamp on it.

In Scouting, we specialize in “wilderness engineering”—the art of building useful things with rope and timber. Your Scouts will probably want to try their hand at it this month.

For Scouts who enjoy making things, recommend that they try to earn the Engineering merit badge. It will expose them to various facets of engineering, and it may lead them to work on such other merit badges as Computers, Drafting, Electricity, and Electronics.

The big event will be a campout during which patrols can do some wilderness engineering and enjoy interpatrol competitions.

## SCOUTING OUTCOMES

This month's patrol and troop activities should give your Scouts

- Enhanced outdoor skills, especially in knot-tying, lashings, and engineering
- A greater understanding of the importance of conservation

- An understanding of some of the principles of engineering as they build temporary structures and camp equipment
- Enhanced self-confidence

## ADVANCEMENT OPPORTUNITIES

By month's end, all Scouts should have met many of their basic pioneering and camping requirements through First Class. Depending on the campout activities, they may also complete all or part of the following rank requirements:

### *Tenderfoot*

- Outdoor—cooking, hiking, camping
- Citizenship—flag ceremonies
- Patrol/troop participation—patrol identification
- Personal development—Scout Oath and Law

### *Second Class*

- Outdoor—cooking, camping, hiking
- Citizenship—flag ceremonies
- Patrol/troop participation—patrol identification
- Personal development—Scout Oath and Law

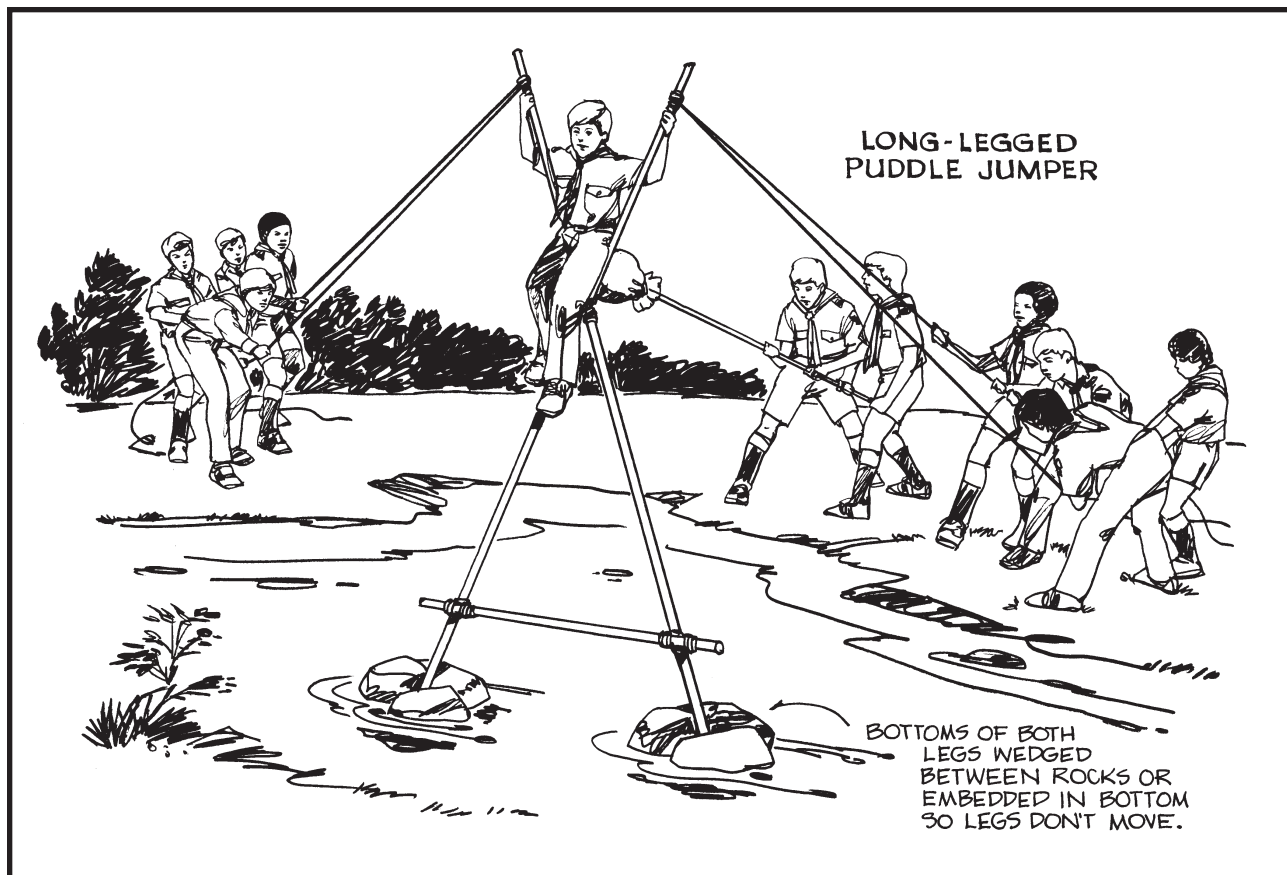

### *First Class*

- Outdoor—cooking, camping, nature, hiking
- Citizenship—flag ceremonies
- Patrol/troop participation—patrol identification
- Personal development—Scout Oath and Law

*Merit Badges.* Older Scouts can concentrate on the Camping and Pioneering merit badges this month; they should be able to complete many of the requirements. Depending on activities during the campout, they may also cover requirements in Cooking, Hiking, Pioneering, Wilderness Survival, and other outdoor-related merit badges.

### **PARENT/GUARDIAN PARTICIPATION**

The patrol leaders' council may involve parents in the program feature this month by

- Asking those qualified to help with instruction for camping, pioneering, and engineering skills
- Inviting them on the campout
- Asking them to provide transportation to the campsite

### **PATROL LEADERS' COUNCIL**

The patrol leaders' council should meet during the early part of the previous month to plan troop activities for this program feature. If you don't complete all items on the following agenda, continue planning at patrol leaders' council meetings after each troop meeting.

- Decide on a campout site. Remember that you will need a supply of poles and small limbs for pioneering projects. Such materials, cut to size, are available at some Scout camps. If your council's camp does not have them, make sure you can get permission to obtain suitable materials elsewhere. Do not cut trees at any site without the owner's permission.
- Plan the special activities for the campout. See the ideas on these pages. If special gear will be needed, assign someone to obtain it; seek help from the troop committee if necessary.
- Inventory the troop's camping equipment, if not done recently.
- Plan details of troop meetings for the month. Assign patrol demonstrations, covering skills that will be needed for the campout activities.
- Practice knots and lashing, if equipment is available.

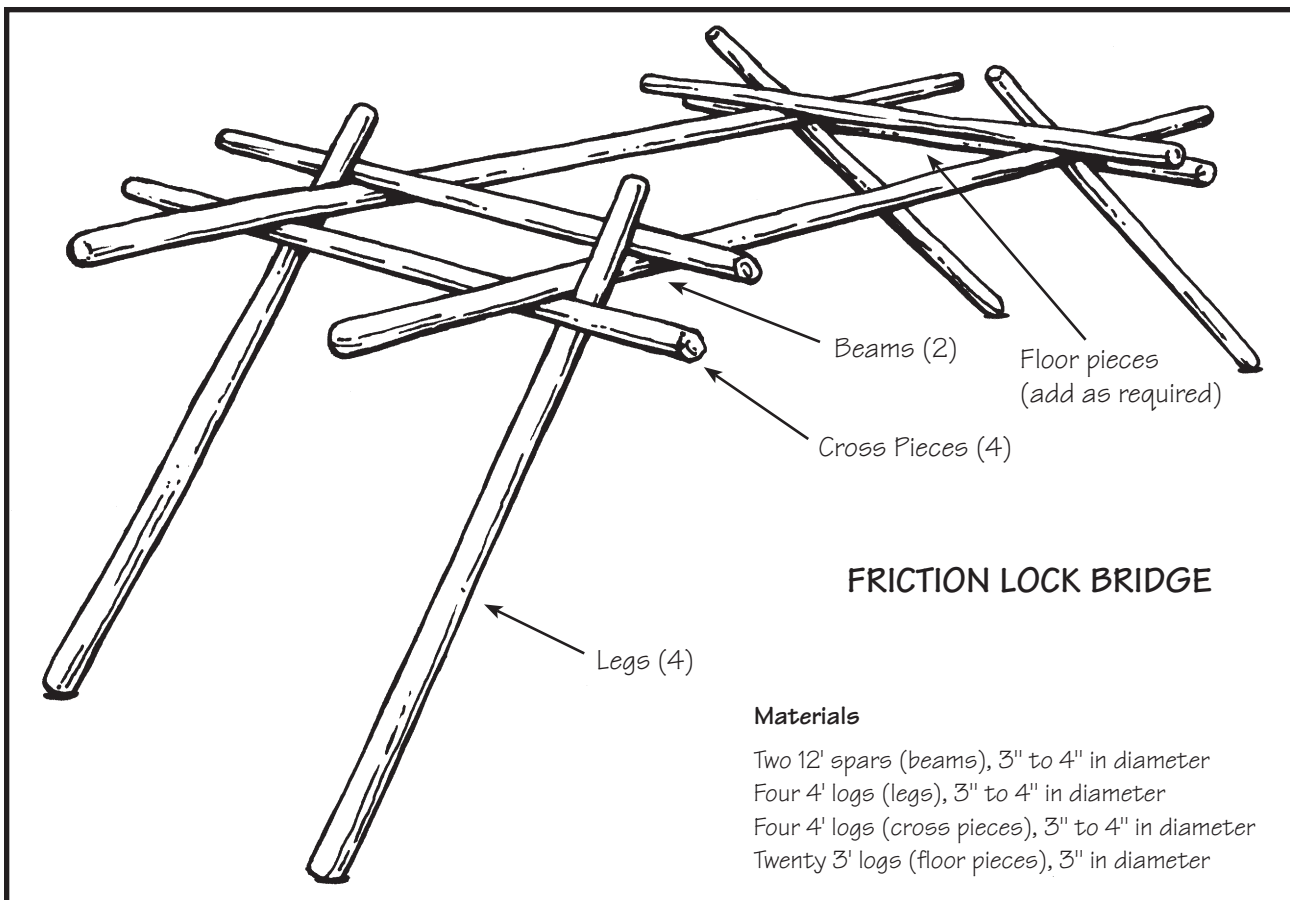

## FEATURE EVENT

### Engineering Outing

During this campout, the troop can build pioneering projects engineered by the experienced Scouts or demonstrate various “engineering” projects. Examples: a scaled-down version of a wind generator and how it stores energy in batteries, or a solar energy battery charger. Or Scouts could design, make, and demonstrate model rockets, cars, or homes during the campout.

Prepare a sketch or drawing on a computer. Take the drawing or sketch and build the project. See if your design really works.

## CAMPOUT GAMES

### LOG HITCHING RACE

**Equipment:** A log, 6 inches in diameter, 5 feet long; 20 to 30 feet of ¼-inch rope; a timepiece to time the race.

**Method:** In turn, each patrol ties a timber hitch and a half hitch on the log and drags it around a turning point 50 feet away and back to the start. A judge times each performance.

**Scoring:** The patrol with the fastest time wins.

## LASHING RELAY

**Equipment:** For each patrol, lashing rope and tree spars, each about 2 to 3 inches in diameter, 6 to 10 feet long.

**Method:** Patrols line up, relay fashion, facing their spars and rope. A judge stands near their equipment. On signal, the first Scout in each patrol runs to the judge and is told to tie one lashing—square, diagonal, or shear. When he has completed the lashing to the judge’s satisfaction, he unties the lashing and runs back to touch off the next patrol member. The relay continues until all have run.

**Scoring:** The first patrol finished wins.

## HIGH HOT CHOCOLATE

**Equipment:** For each patrol, poles and lashing ropes for a four-legged tower that is 8 feet high with a 4’-by-4’ square platform at the top; water, small pot, cup, spoon, instant chocolate mix, 2’-by-2’ square of plywood, sand for fire bed.

**Method:** Each patrol assembles its tower. One member then climbs up and makes a fireplace of sand on the

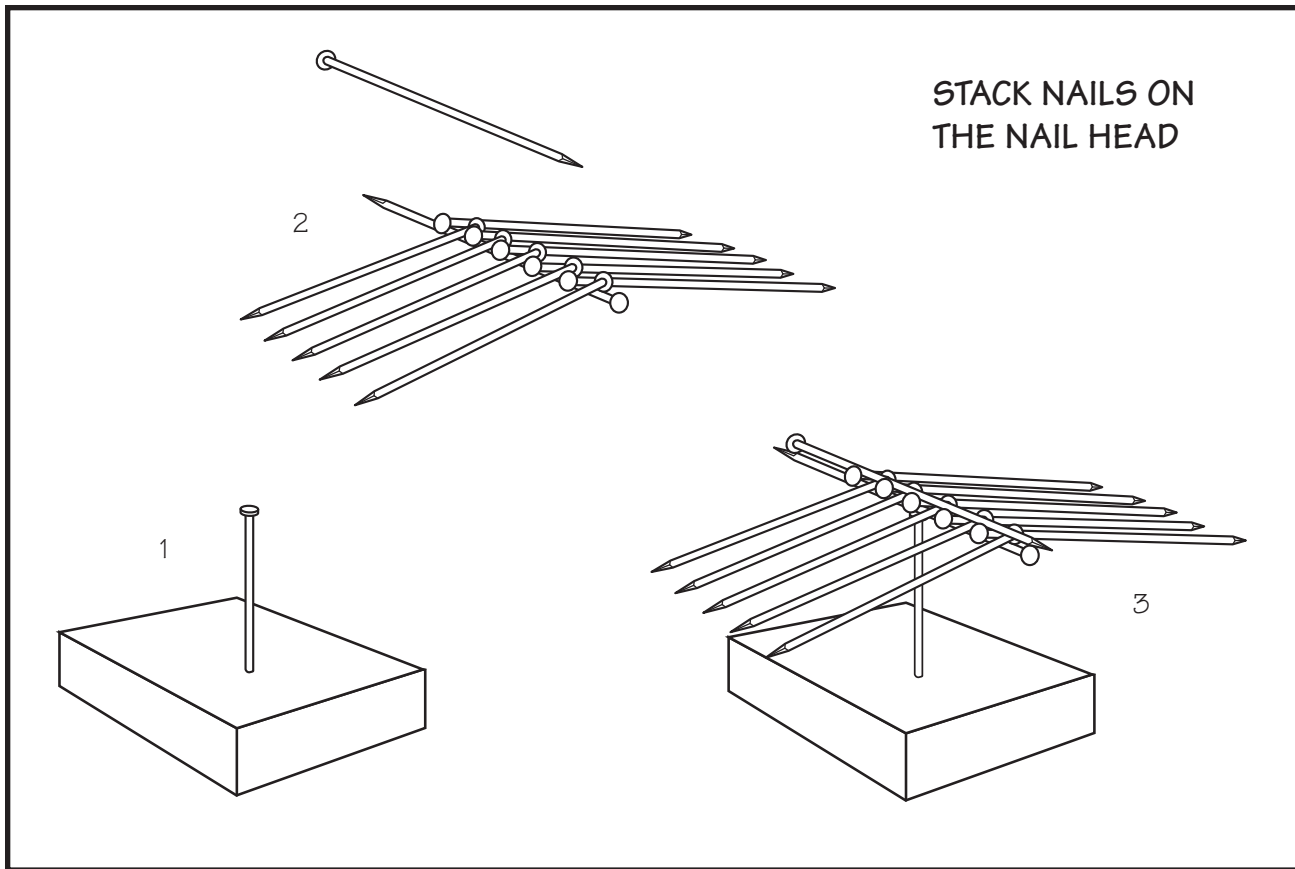

plywood square. He builds a small fire on the sand, boils a cup of water, and makes hot chocolate.

**Scoring:** The first patrol to give the Scoutmaster a cup of hot chocolate wins.

**Friction Lock Bridge**

**Equipment**

- Two 12' spars (beams), 3" to 4" in diameter
- Four 4' logs (legs), 3" to 4" in diameter
- Four 4' logs (cross pieces), 3" to 4" in diameter
- Twenty 3' logs (floor pieces), 3" in diameter

A friction lock bridge is a fun engineering project for a patrol to construct. Put the two 12-foot spars in place, and then the legs, and lock in the beams. (See the diagram.) Cover with flooring.

**Stack Nails on the Nail Head**

Drive a 4-inch nail into a block of wood about one-half inch. Have 12 other 4-inch nails, and challenge the group to stack all 12 nails on the head of the nail in the block. Allow Scouts to make an attempt. You will need to stress that no other objects such as rubber bands are allowed. After a few attempts, show how to stack the nails. Lay one nail on a flat surface. Place five nails on the nail laying flat, with the head about one-quarter inch past the nail laying flat. Place five more nails in the opposite direction, in between each nail. The one remaining nail should be placed on top, in the opposite direction of the nail laying flat. Carefully pick up the two nails and the other 10 will lock into place. Center the nails on the nail head on the block of wood. (See the diagram.)

# ENGINEERING

## TROOP MEETING PLAN

Date \_\_\_\_\_ Week 1

ACTIVITY	DESCRIPTION	RUN BY	TIME
<b>Preopening</b> _____ minutes	Have some professional engineers in different fields bring in the “tools” of their trade to show what they do. These may be blueprints that show what kind of designing they do.		
<b>Opening Ceremony</b> _____ minutes	<ul style="list-style-type: none"> <li>• Form the troop into a horseshoe.</li> <li>• Hold a uniform inspection.</li> <li>• Repeat the Scout Oath.</li> </ul>		
<b>Skills Instruction</b> _____ minutes	<ul style="list-style-type: none"> <li>• New Scouts practice tying the clove hitch, square knot, and bowline. Do Rescue Race. (See the Games section of the <i>Troop Program Resources</i>. *)</li> <li>• Experienced Scouts arrange to visit an engineering firm or engineering department in industry. Or, design several pioneering projects that could be built with Scout staves.</li> <li>• Older Scouts work on the Venture program or study ropes and knots needed for rappelling (<i>Fieldbook</i>).</li> </ul>		
<b>Patrol Meetings</b> _____ minutes	Discuss plans for the outing this month and make sure everyone knows his assignments. If the outing will be an overnigher, begin meal planning and patrol duty roster, and plan for equipment distribution and tent requirements. Any Scouts who have not been camping will need extra help. All other patrols work on plans for activities towards the next rank advancement.		
<b>Interpatrol Activity</b> _____ minutes	Play Reactor Transport. (See the Games section of the <i>Troop Program Resources</i> . *)		
<b>Closing</b> _____ minutes Total 90 minutes of meeting	<ul style="list-style-type: none"> <li>• Sing “Scout Vespers.”</li> <li>• Scoutmaster’s Minute.</li> <li>• Retire colors.</li> </ul>	SM	
<b>After the Meeting</b>	Patrol leaders’ council reviews the next meeting and plans for the outing. Begin work on next month’s program feature.		

\*Troop Program Resources for Scout Troops and Varsity Teams, Supply No. 33588

# ENGINEERING

## TROOP MEETING PLAN

Date \_\_\_\_\_ Week 2

ACTIVITY	DESCRIPTION	RUN BY	TIME
<b>Preopening</b> _____ minutes			
<b>Opening Ceremony</b> _____ minutes			
<b>Skills Instruction</b> _____ minutes	<ul style="list-style-type: none"> <li>• New Scouts review knots practiced last week and begin learning lashings. Do Knot-Tying Relay. (See the Games section of the <i>Troop Program Resources</i>.)</li> <li>• Experienced Scouts continue work on pioneering projects or visit an engineering firm.</li> <li>• Older Scouts work on the Venture program or plan to catch and cook fish for a meal on the troop's outing.</li> </ul>		
<b>Patrol Meetings</b> _____ minutes	Review assignments for the campout. First-time campers continue working on hiking and camping techniques. All other patrols continue to work on advancement activities for the outing. Practice interpatrol activities.		
<b>Interpatrol Activity</b> _____ minutes	Do Stack the Nails on the Nail Head, found in the introduction of this program feature.		
<b>Closing</b> _____ minutes Total 90 minutes of meeting	<ul style="list-style-type: none"> <li>• Sing "Scout Vespers."</li> <li>• Scoutmaster's Minute.</li> <li>• Retire colors.</li> </ul>	SM	
<b>After the Meeting</b>	Patrol leaders' council reviews the next meeting and plans for the outing. Continue work on next month's program feature.		

\*Troop Program Resources for Scout Troops and Varsity Teams, Supply No. 33588



# ENGINEERING

## TROOP MEETING PLAN

Date \_\_\_\_\_ Week 3

ACTIVITY	DESCRIPTION	RUN BY	TIME
<b>Preopening</b> _____ minutes			
<b>Opening Ceremony</b> _____ minutes			
<b>Skills Instruction</b> _____ minutes	<ul style="list-style-type: none"> <li>• New Scouts practice use and care of woods tools, and learn how to make firelays. Continue work on lashings.</li> <li>• Experienced Scouts make assignments to get necessary staves, spars, and ropes for pioneering projects on the campout.</li> <li>• Older Scouts work on the Venture program or assist with instruction of younger Scouts. Or, visit an engineering firm.</li> </ul>		
<b>Patrol Meetings</b> _____ minutes	Finalize the menu for the outing and make sure everyone knows what to bring. Review clothing and equipment needs and collect necessary fees. Practice interpatrol activities.		
<b>Interpatrol Activity</b> _____ minutes	Play Log-Rolling Relay. (See the Games section of the <i>Troop Program Resources</i> .*)		
<b>Closing</b> _____ minutes  Total 90 minutes of meeting	<ul style="list-style-type: none"> <li>• Scoutmaster's Minute.</li> <li>• Retire colors.</li> </ul>	SM	
<b>After the Meeting</b>	Patrol leaders' council reviews the next meeting and plans for the outing. Continue work on next month's program feature.		

\*Troop Program Resources for Scout Troops and Varsity Teams, Supply No. 33588

# ENGINEERING

## TROOP MEETING PLAN

Date \_\_\_\_\_ Week 4

ACTIVITY	DESCRIPTION	RUN BY	TIME
<b>Preopening</b> _____ minutes			
<b>Opening Ceremony</b> _____ minutes			
<b>Skills Instruction</b> _____ minutes	<ul style="list-style-type: none"> <li>• New Scouts use lashing to construct a catapult.</li> <li>• Experienced Scouts finalize plans for pioneering projects and any demonstrations of engineering projects planned for the outing.</li> <li>• Older Scouts work on the Venture program or plan an orienteering course that could be run at the campout.</li> </ul>		
<b>Patrol Meetings</b> _____ minutes	Review plans and assignments for the hike/campout. Make sure everyone knows travel plans and equipment needs. Go over the patrol duty roster. Practice interpatrol activities that will take place.		
<b>Interpatrol Activity</b> _____ minutes	Play Long-Legged Puddle Jumper. (See the Games section of the <i>Troop Program Resources</i> .)		
<b>Closing</b> _____ minutes Total 90 minutes of meeting	<ul style="list-style-type: none"> <li>• Scoutmaster's Minute—reflection on the experiences of the month.</li> <li>• Retire colors.</li> </ul>	SM	
<b>After the Meeting</b>	Patrol leaders' council reviews the next meeting and checks last-minute details for the outing. Finalize work on next month's program feature.		

\*Troop Program Resources for Scout Troops and Varsity Teams, Supply No. 33588

# ENGINEERING

## TROOP OUTDOOR PROGRAM PLAN

**Date** \_\_\_\_\_

TIME	ACTIVITY	RUN BY
<b>Friday evening</b>	Load gear at meeting location, leave for campsite. Plan only a light meal en route.	SPL
	Arrive at campsite; off-load equipment. Set up patrol sites. Stow gear and set up camp.	SPL/PL
<b>Saturday</b> 6:30 A.M.	Cooks and assistants up. Prepare breakfast. (Cooks should be working on First and Second Class requirements.)	Cooks, assistants
7:00 A.M.	Everyone else up. Take care of personal hygiene, air tents, hang out sleeping bags.	
7:30 A.M.	Breakfast	
8:00 A.M.	Clean up.	Cooks
	Patrols put up the gear for morning activities, clean up patrol site.	
8:30–11:30 A.M.	Engineering demonstration, pioneering projects.	
11:30 A.M.	Cooks prepare lunch.	Cooks
Noon	Lunch	
12:30 P.M.	Clean up.	Cooks
1 P.M.	Pioneering projects	SPL
4:30 P.M.	Start dinner preparation.	Cooks
5:30 P.M.	Dinner	SPL
6:00 P.M.	Clean up.	Cooks
8:00 P.M.	Campfire	
9:00 P.M.	Cracker barrel	
10:00 P.M.	Lights out	
<b>Sunday</b> 6:30 A.M.	Cooks and assistants up. Prepare breakfast. (Cooks should be working on First and Second Class requirements.)	Cooks, assistants
7:00 A.M.	Everyone else up. Take care of personal hygiene, air tents, hang out sleeping bags.	
7:30 A.M.	Breakfast	
8:00 A.M.	Clean up.	Cooks
	Patrols put up the gear for morning activities, clean up patrol site.	

TIME	ACTIVITY	RUN BY
8:30 A.M.	Worship service	
9:00–11:00 A.M.	Patrol games—use four games from the Games section of the <i>Troop Program Resources</i> . *	
11:00 A.M.	Break camp.	
<b>Special equipment needed</b>	Scout staves, rope, spars, troop camping equipment	

\**Troop Program Resources for Scout Troops and Varsity Teams*, Supply No. 33588

## NOTES

## NOTES

## NOTES

## NOTES